

After Lazare Lenain

# ROSICRUCIAN SIGILS OF THE 72 GENIUSES

Piers Vaughan

Rose Circle Publications  
2020



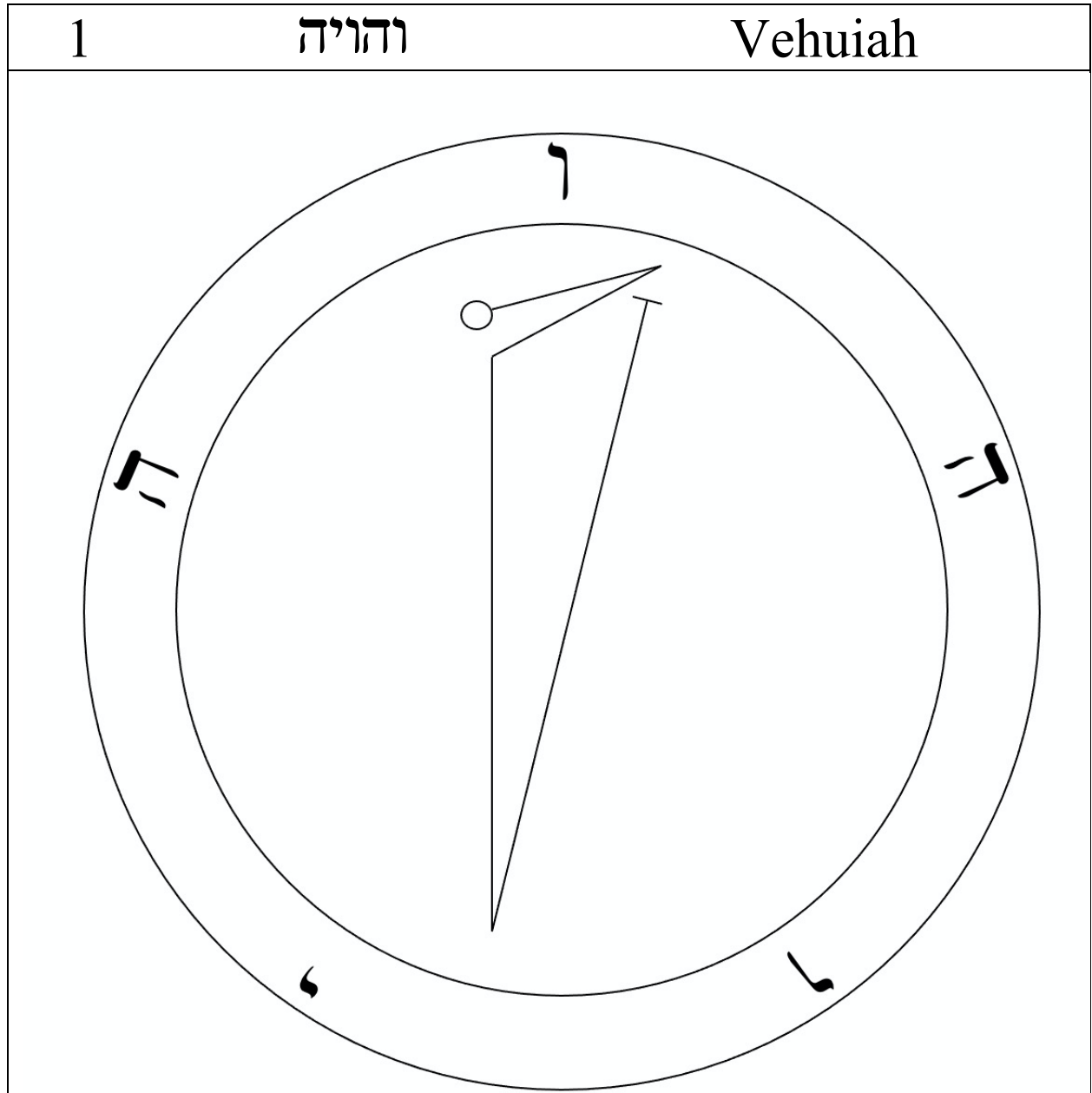

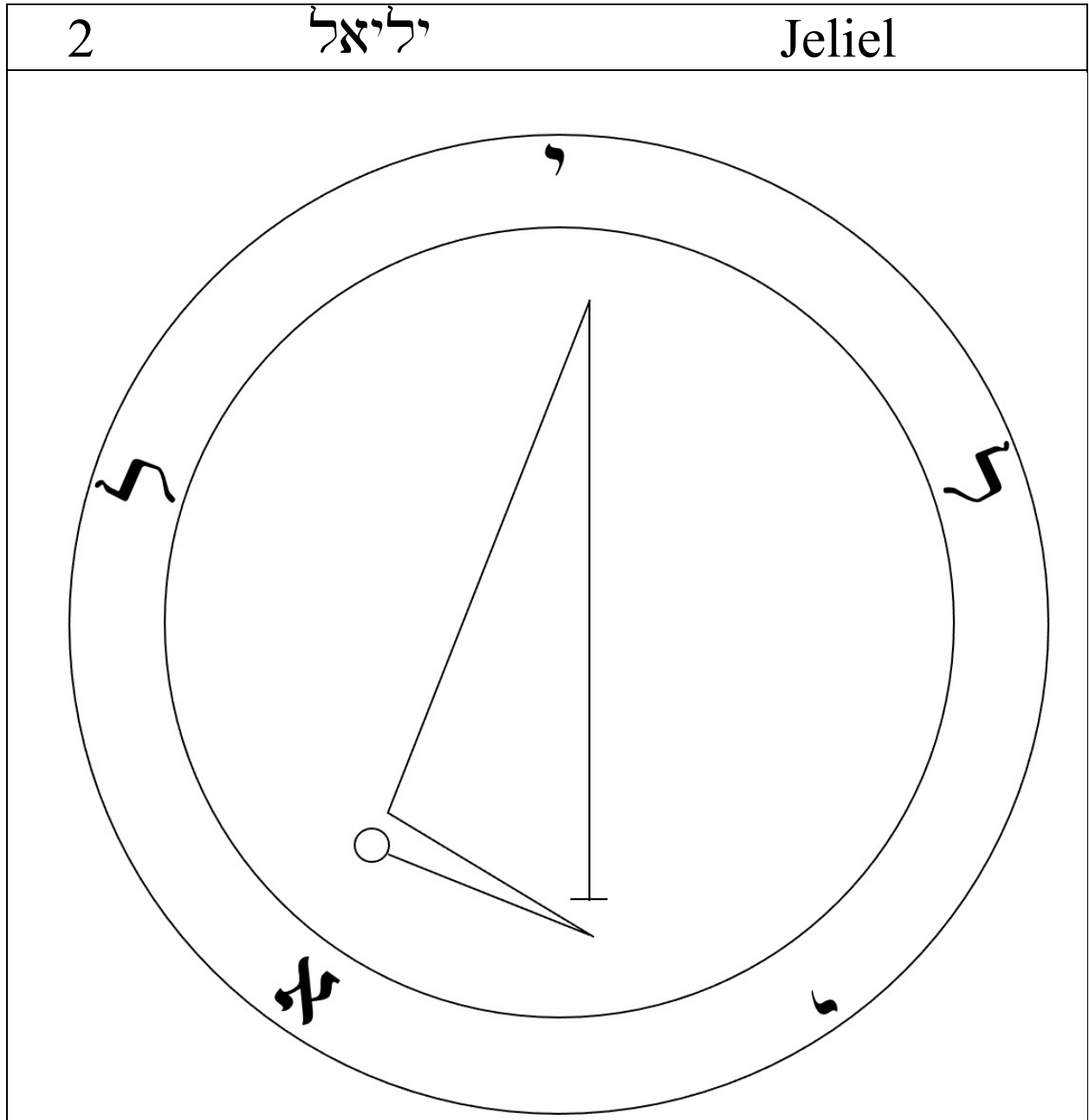

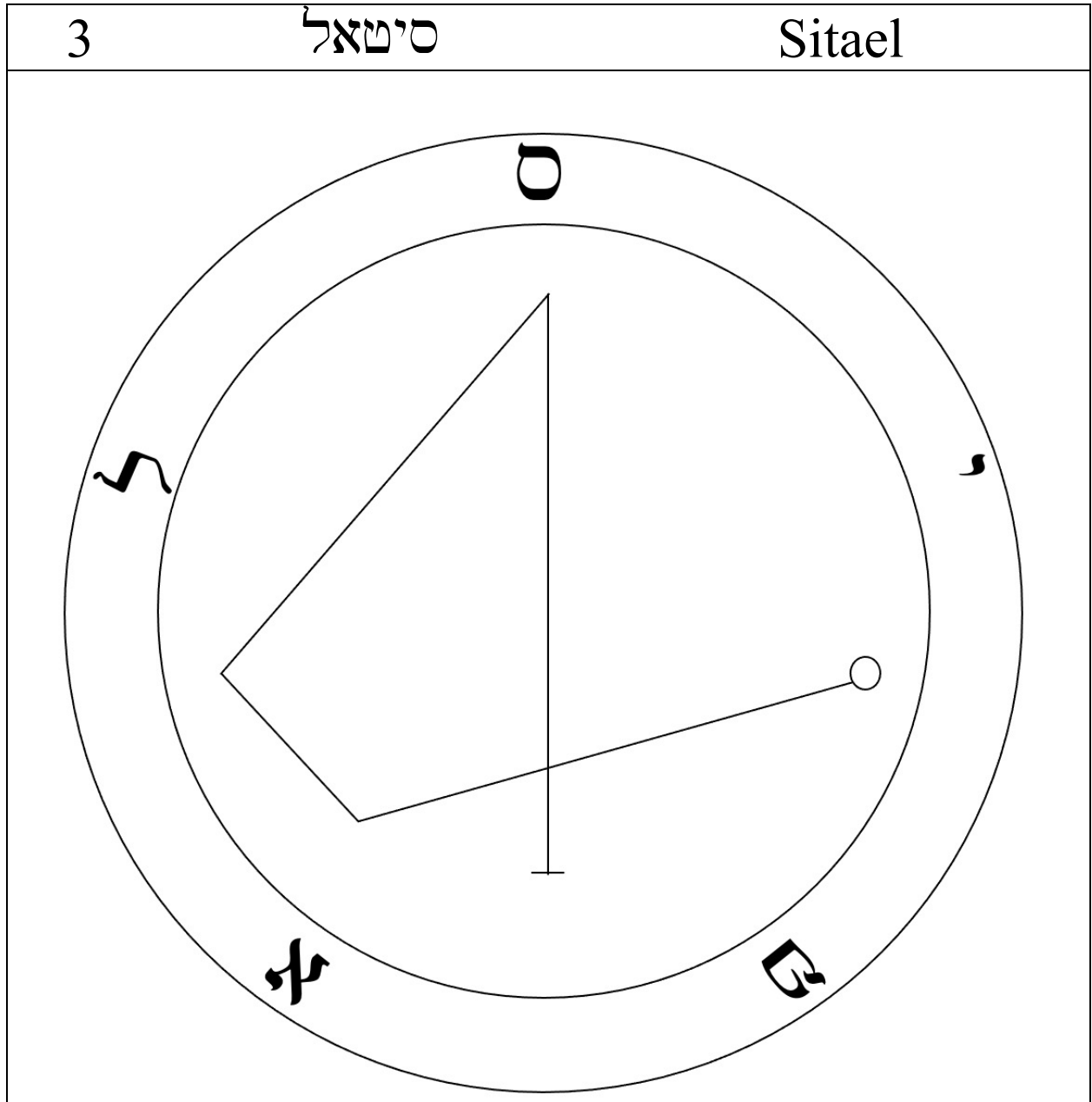

4

עלמיה

Elemiah

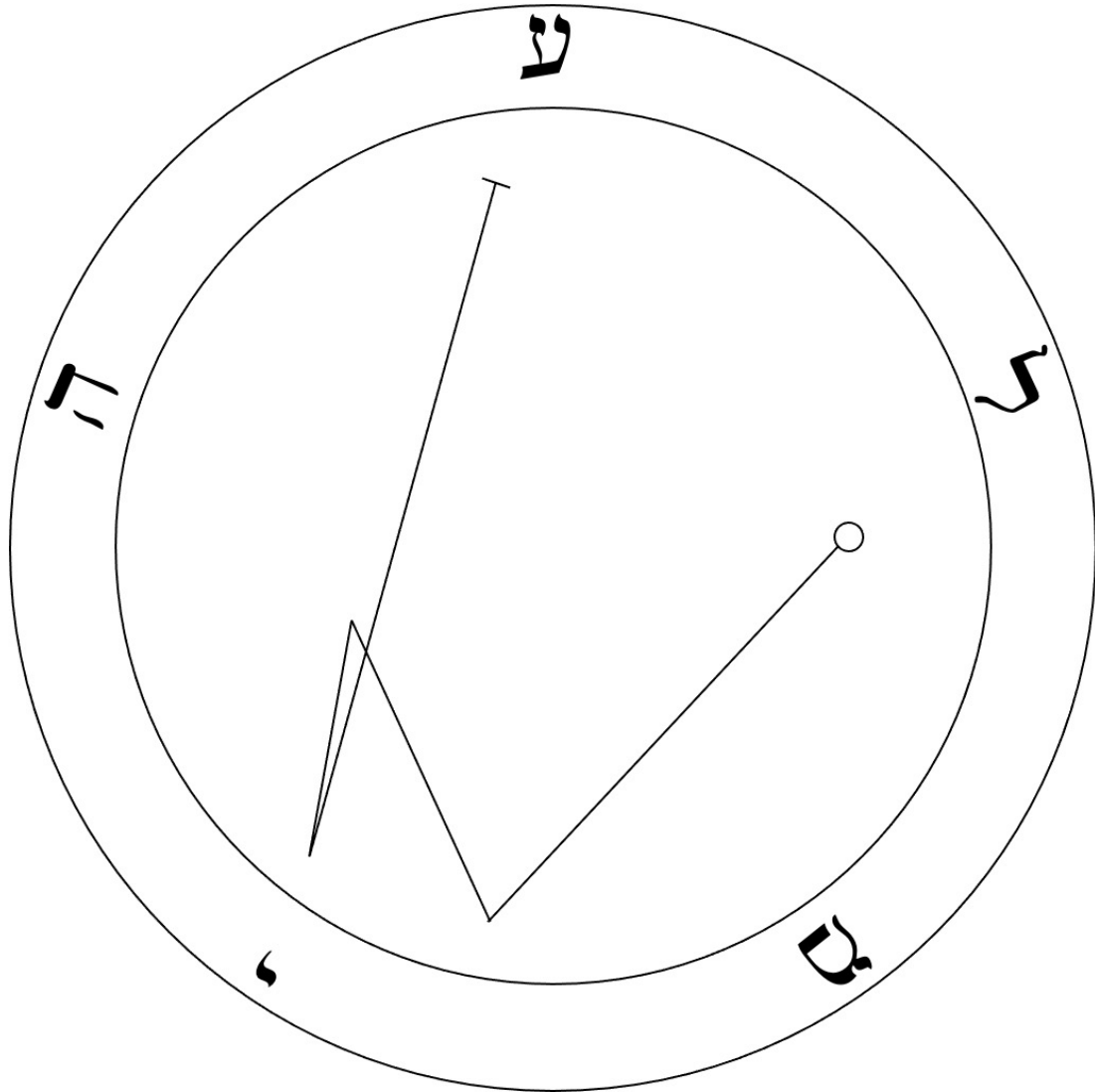

5

מהשיה

Mahasiah

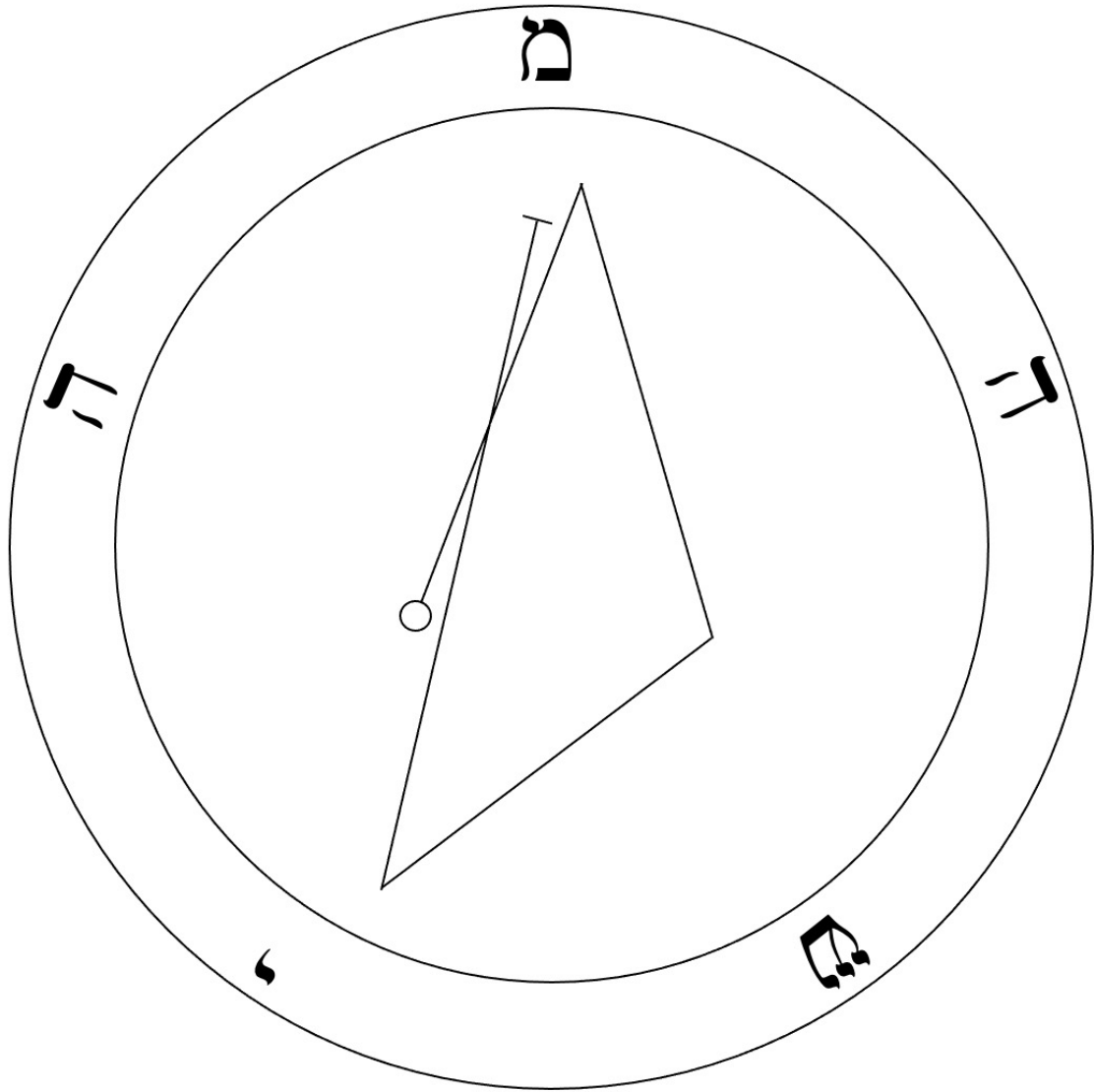

6

ללהאל

Lelahel

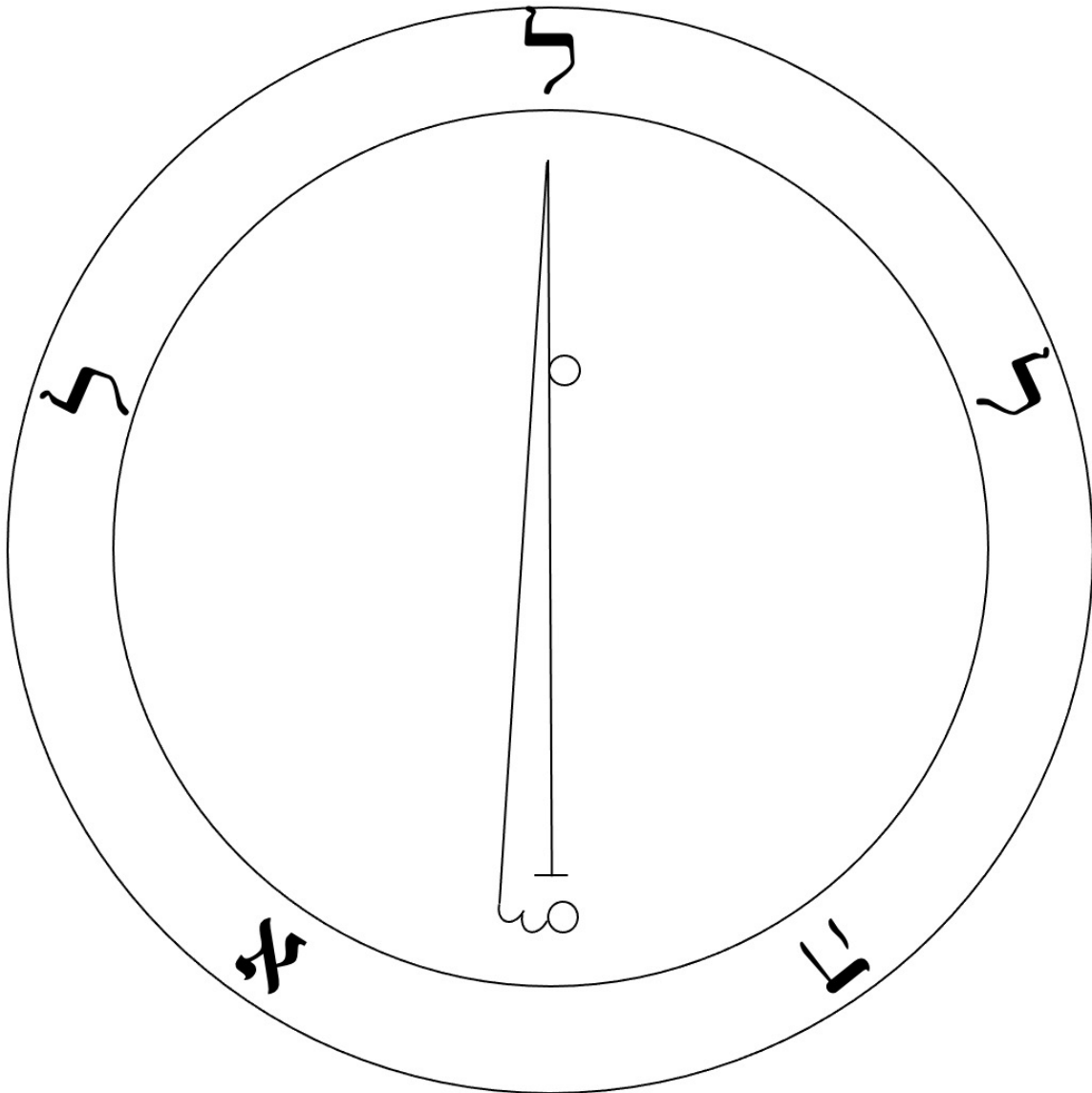

7

אכאיה

Achaiah

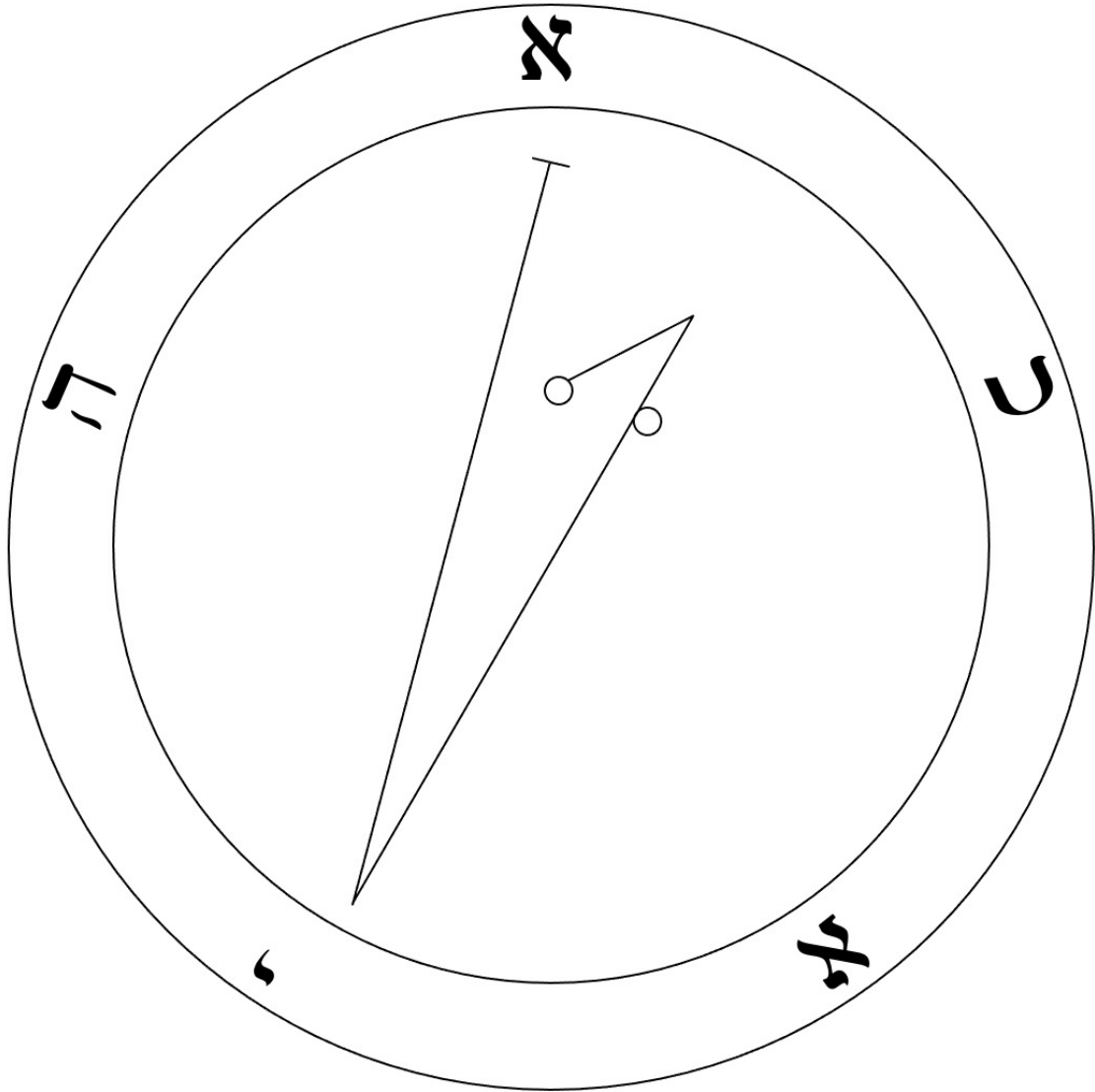



8

כהתאל

Cahethel

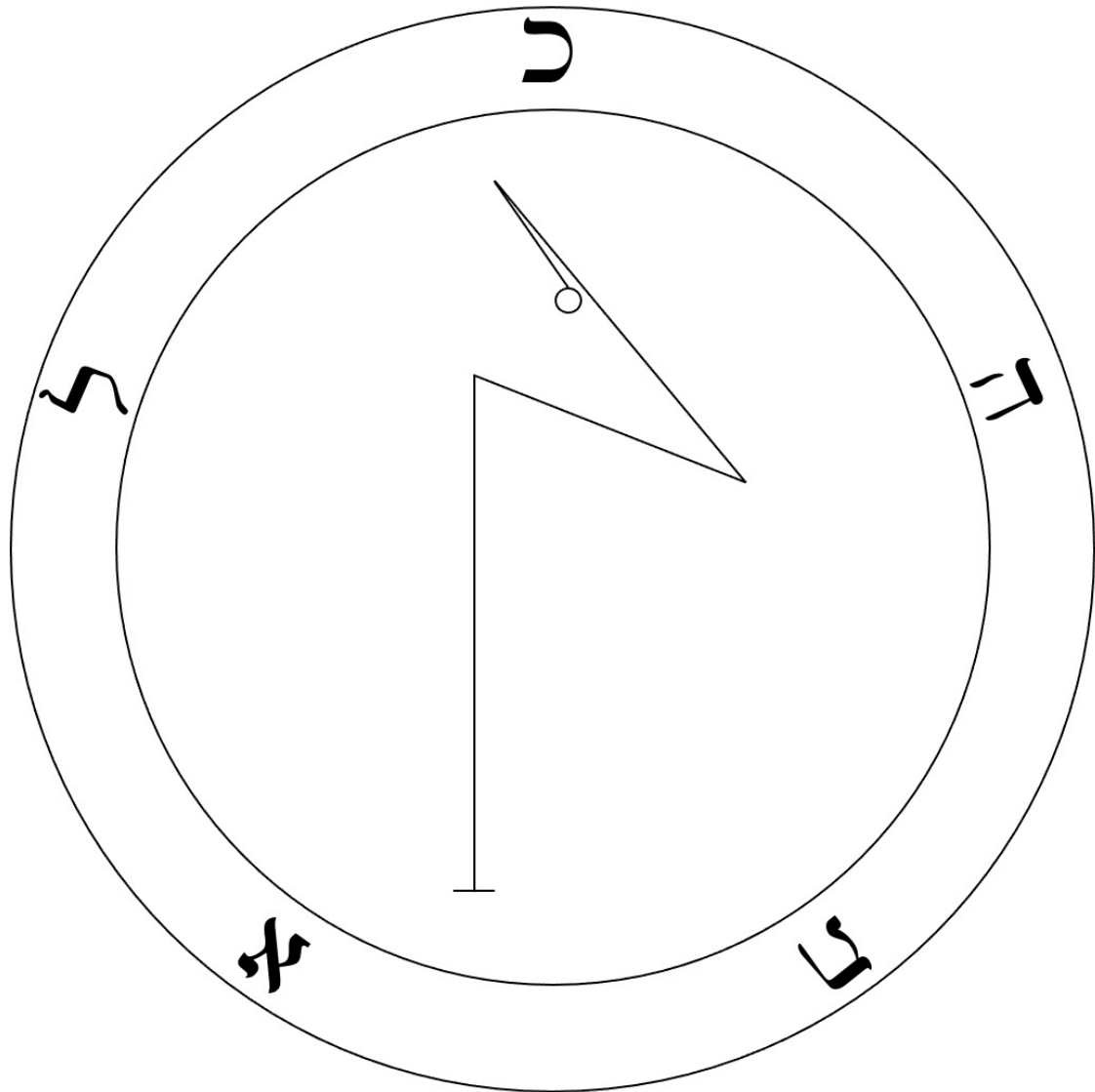

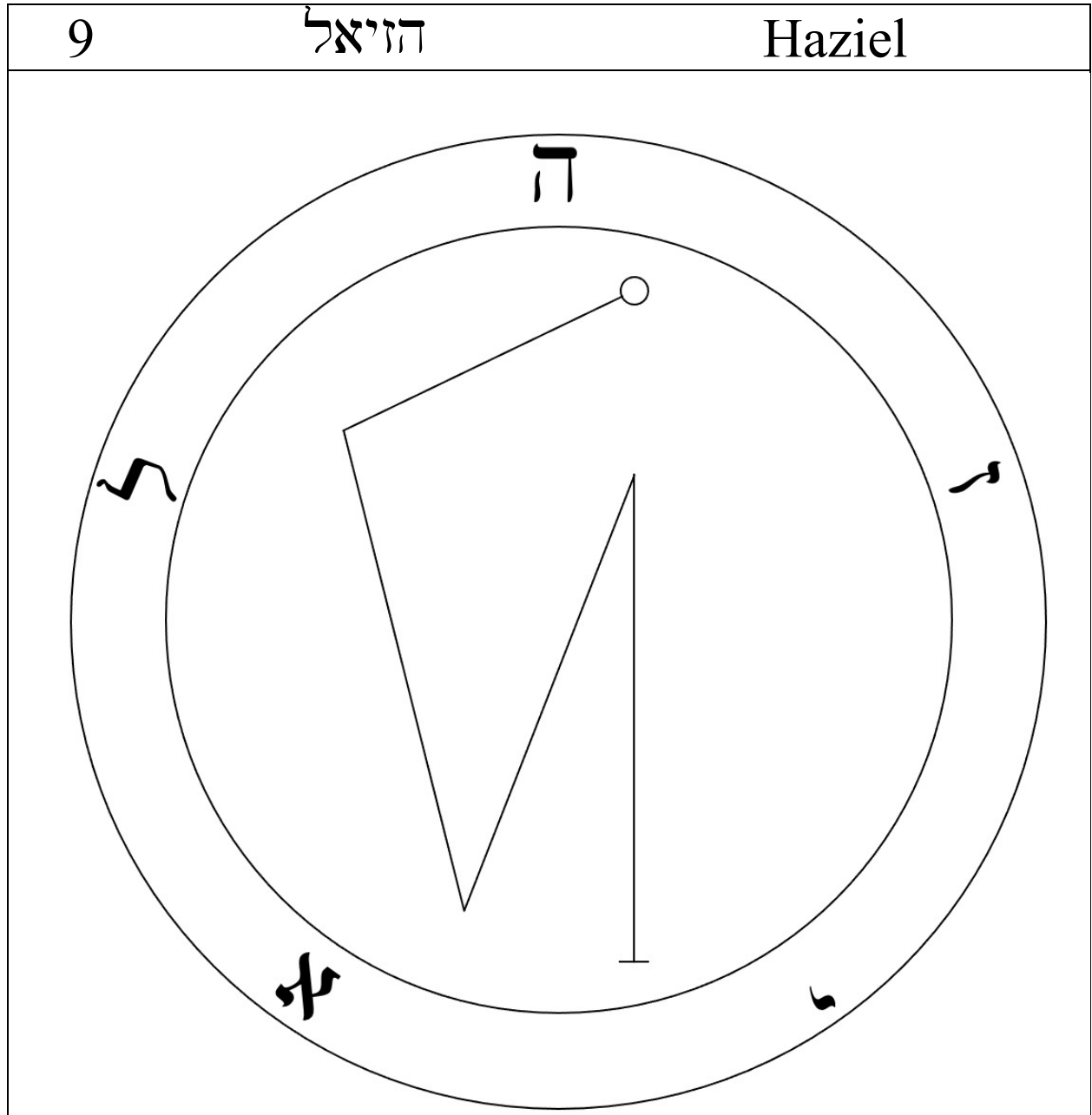

10

אלדיה

Aladiah

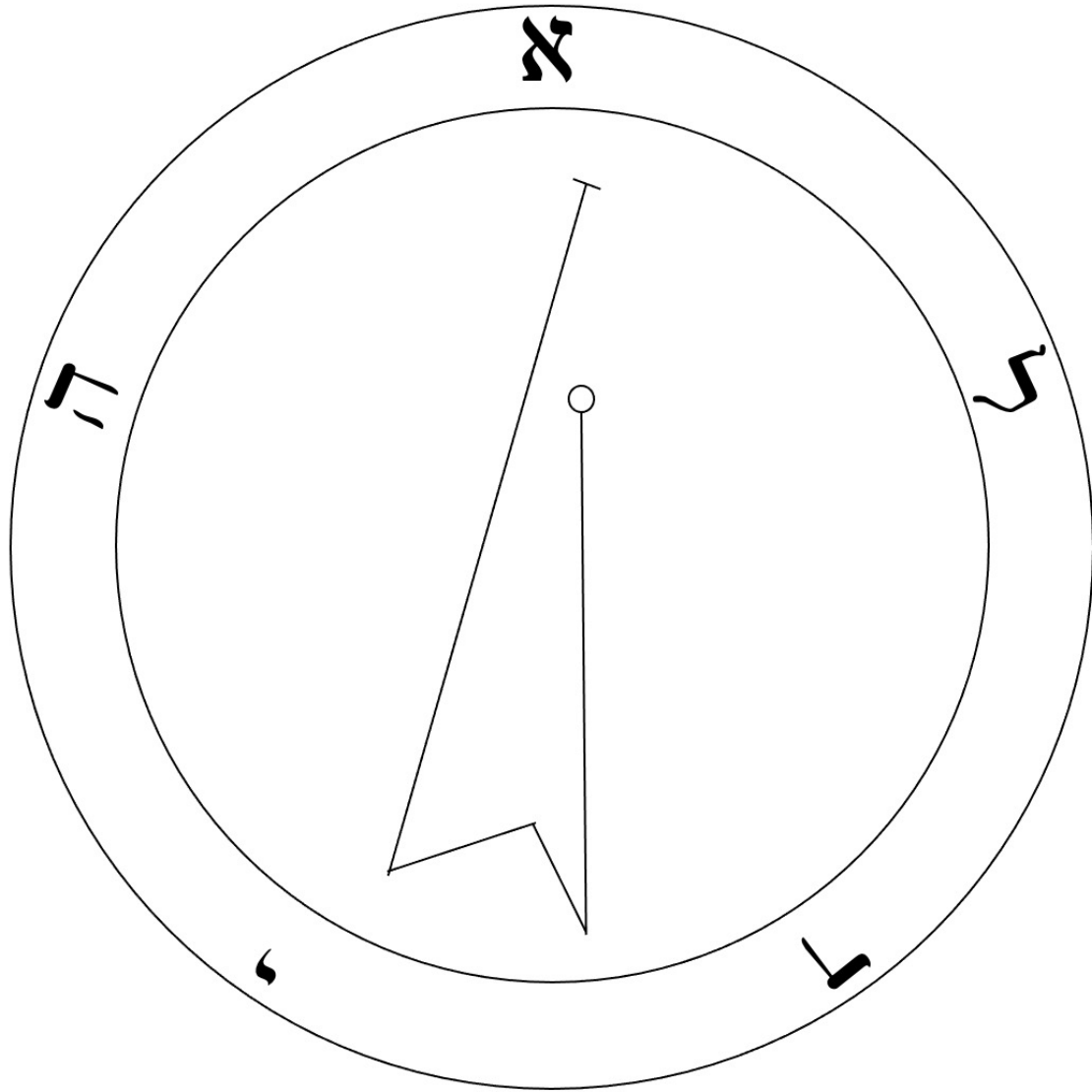

11

לאויה

Lauviah

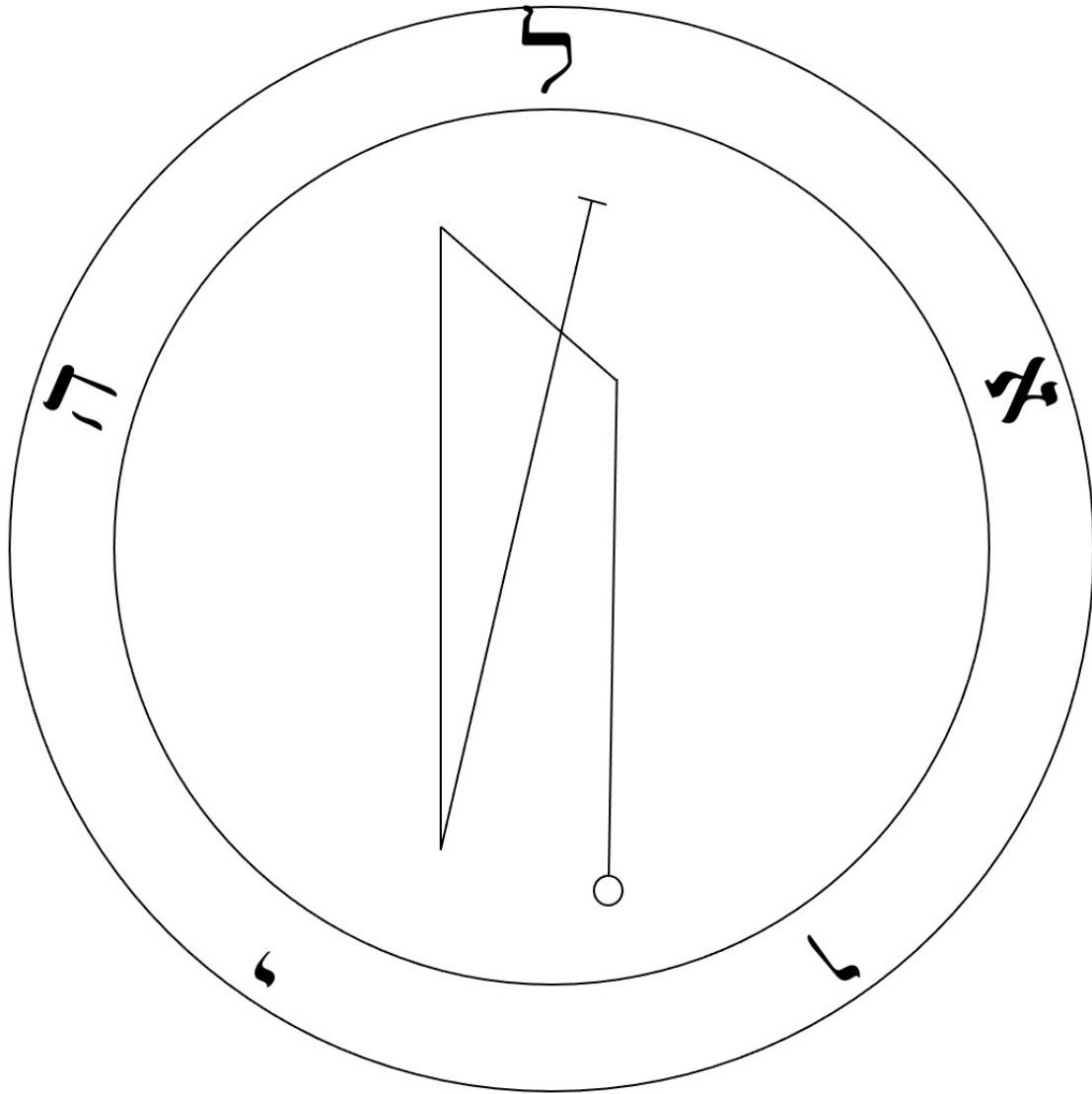

12

הַהַעִיָּה

Hahaiah

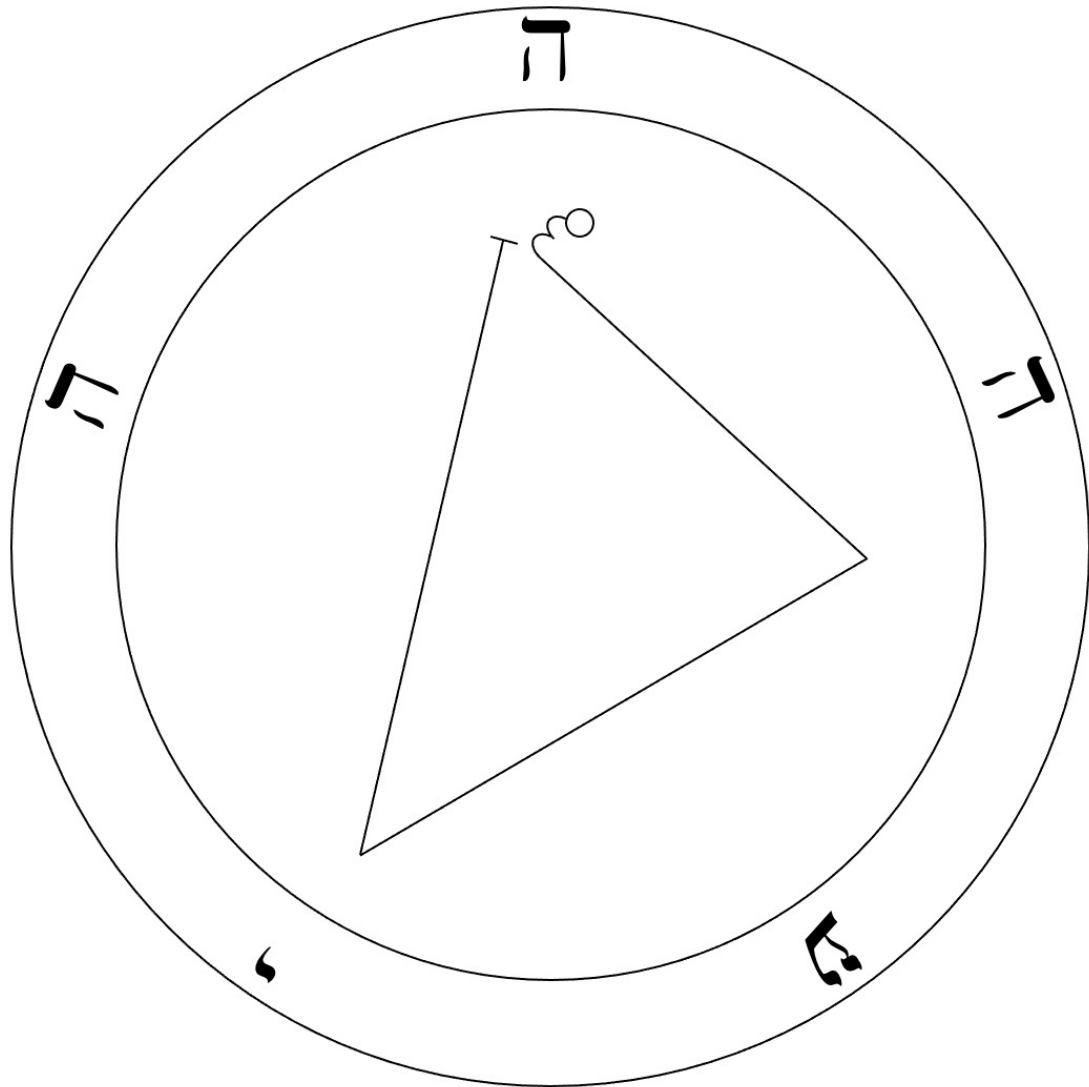

13

יזלאל

Iezalel

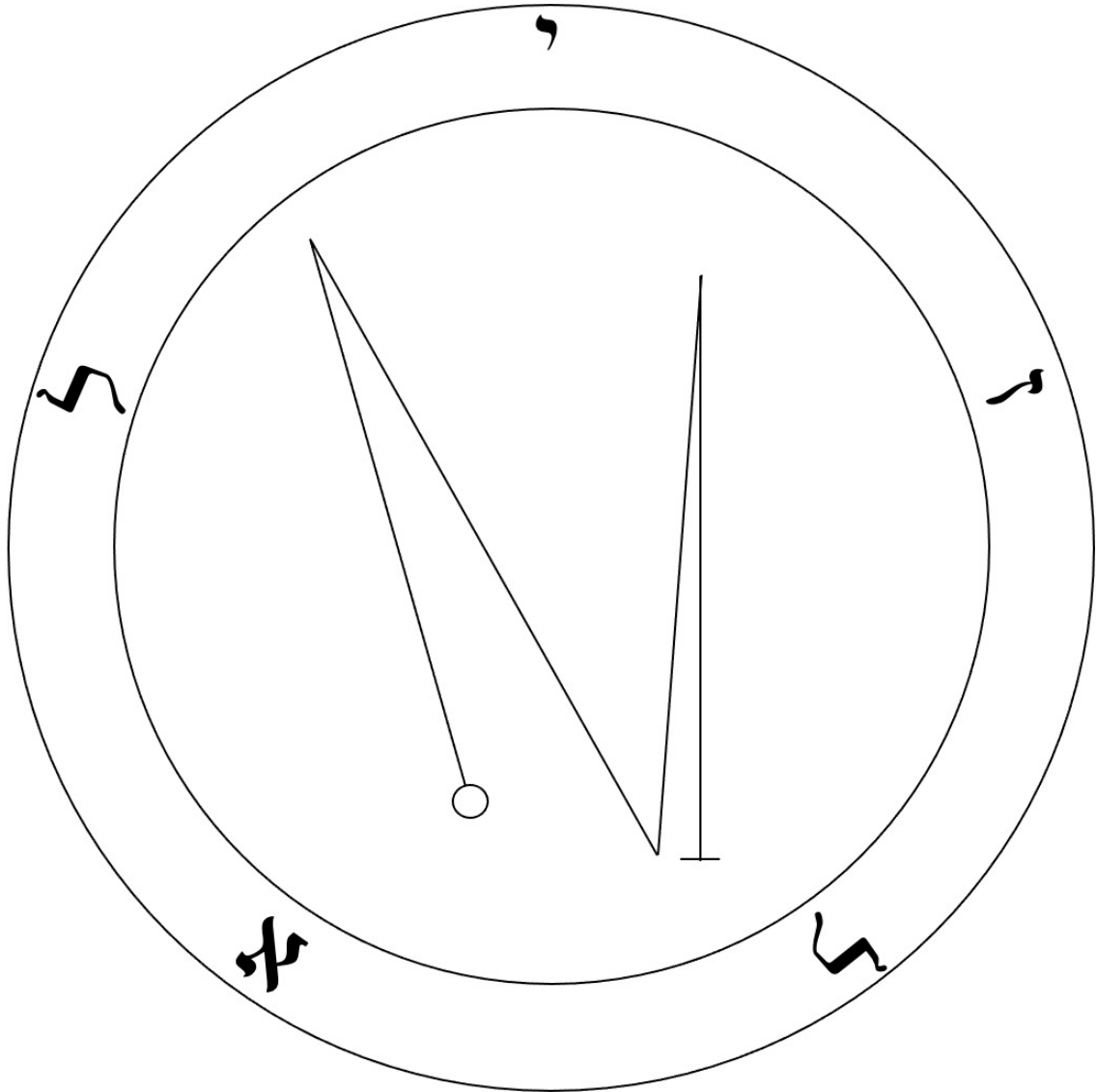

14

מבהאל

Mebahel

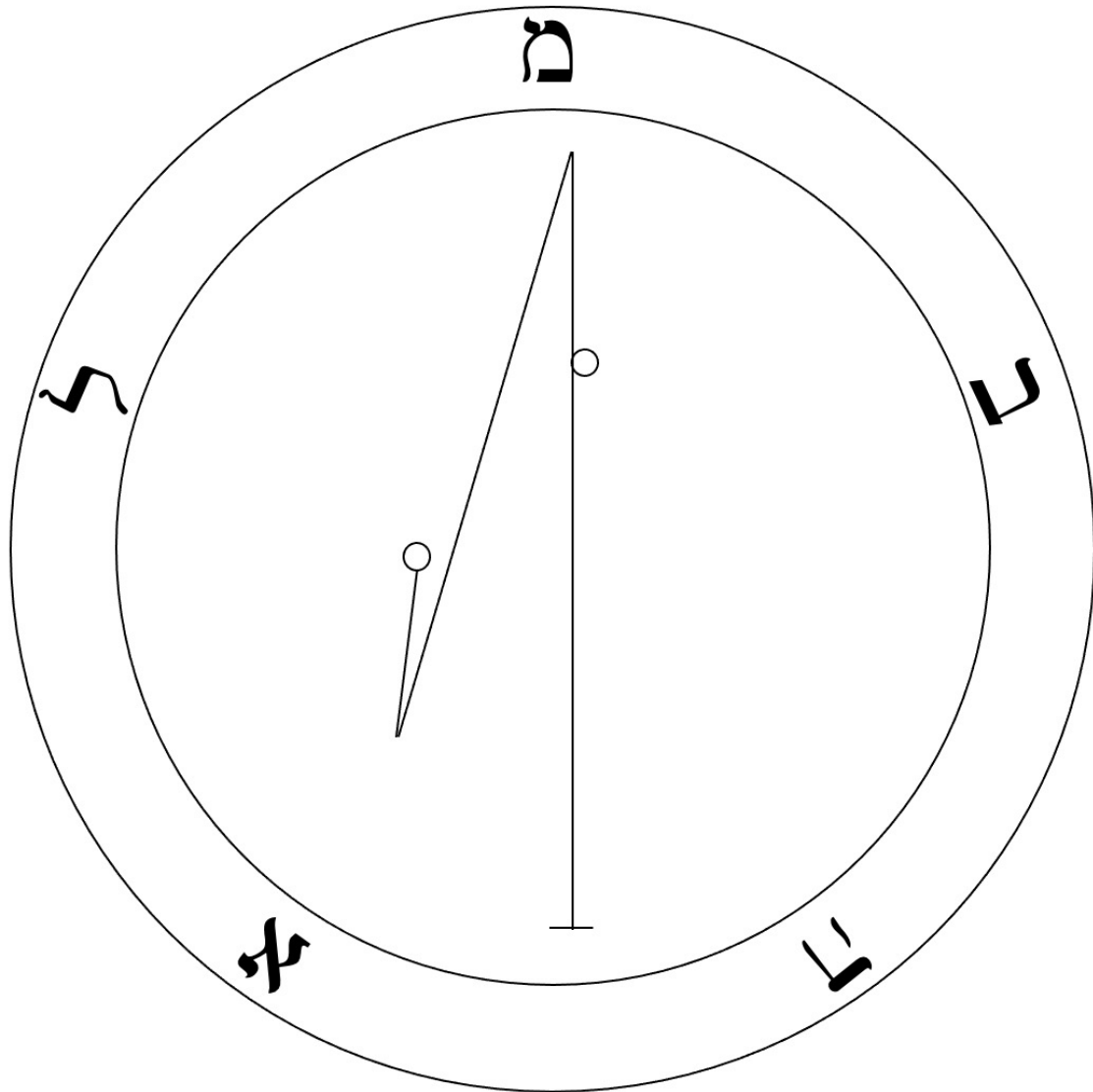

15

הריאל

Hariel

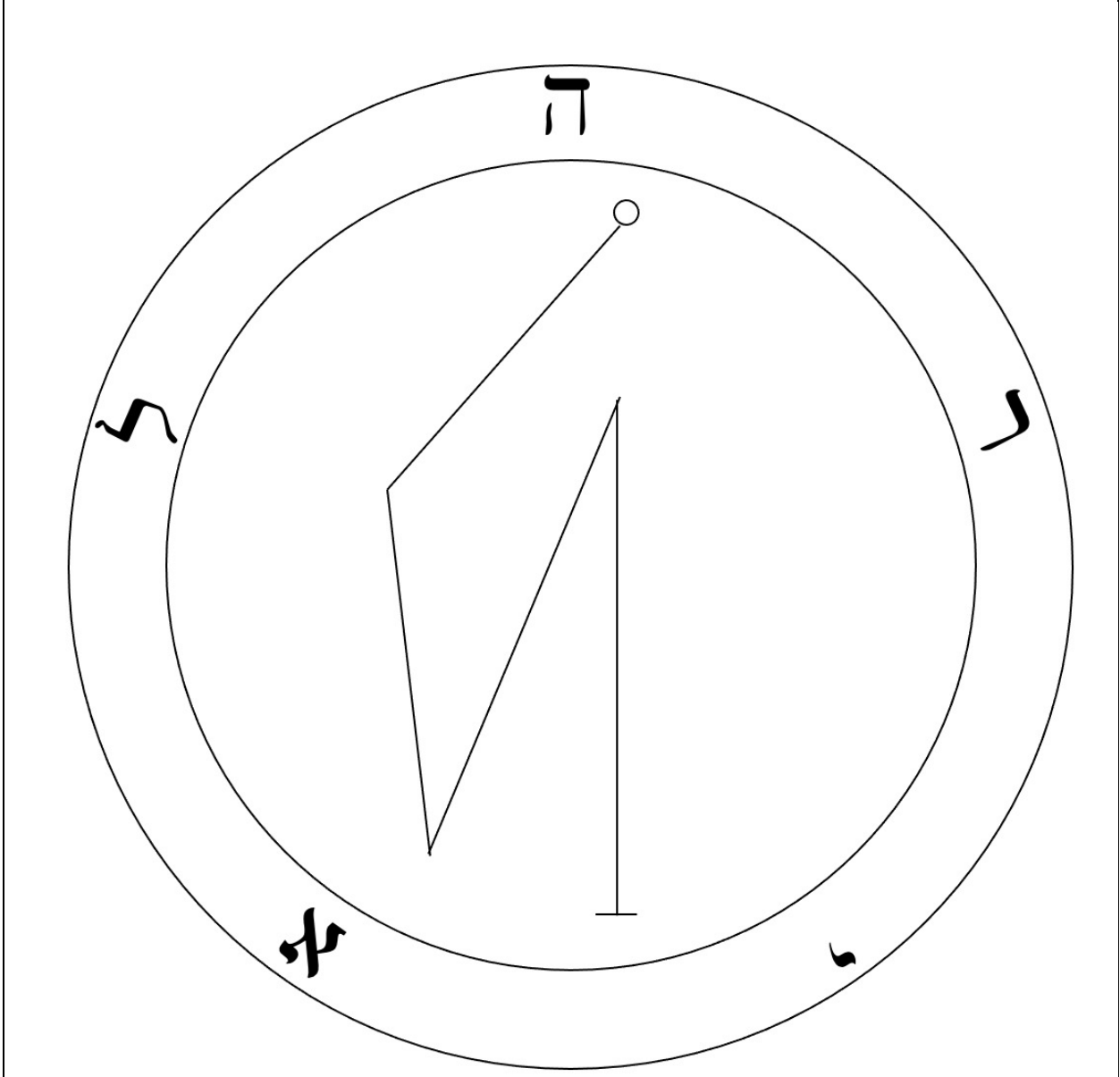



16

הַקַּמִּיָּה

Hakamiah

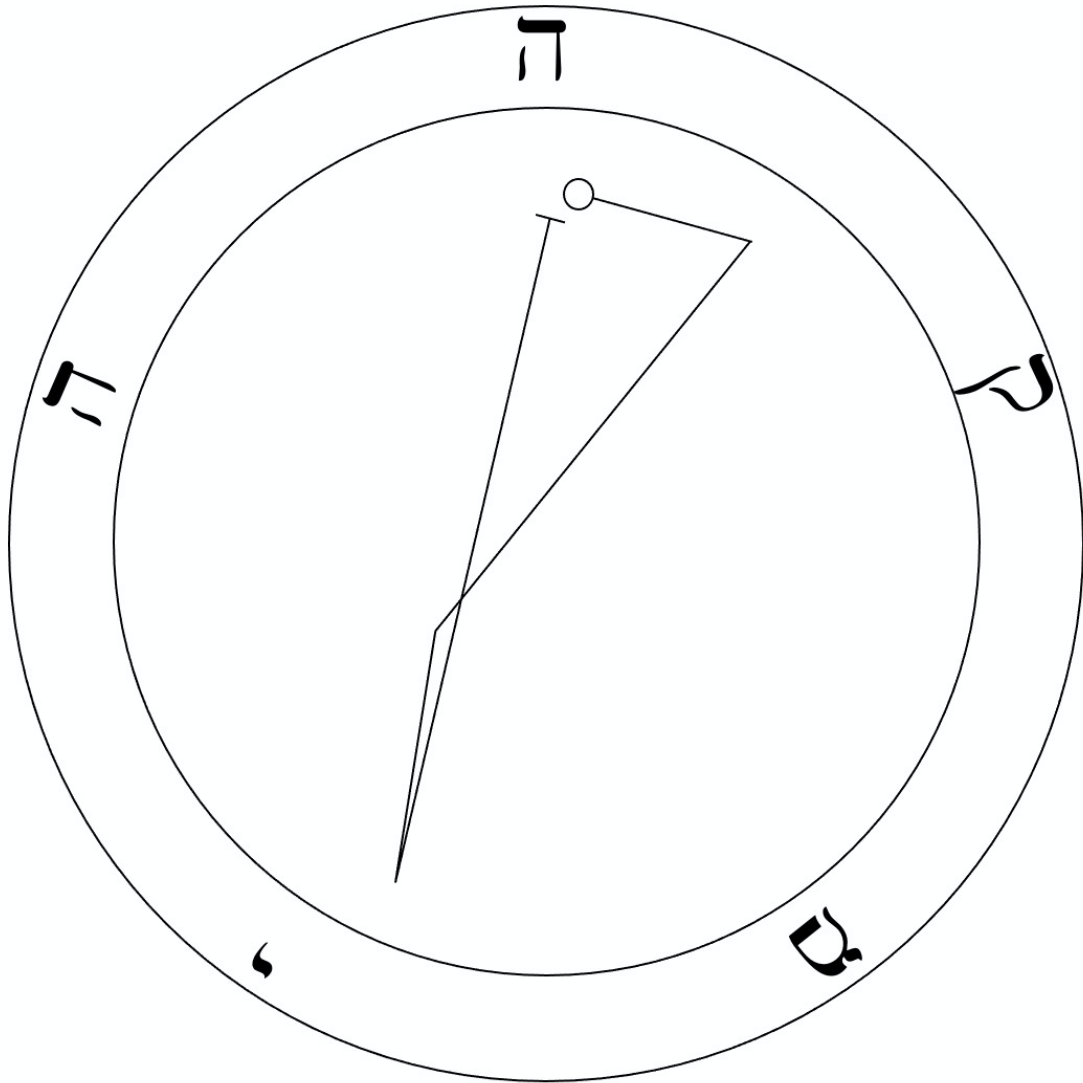

17

לאויה

Lauviah

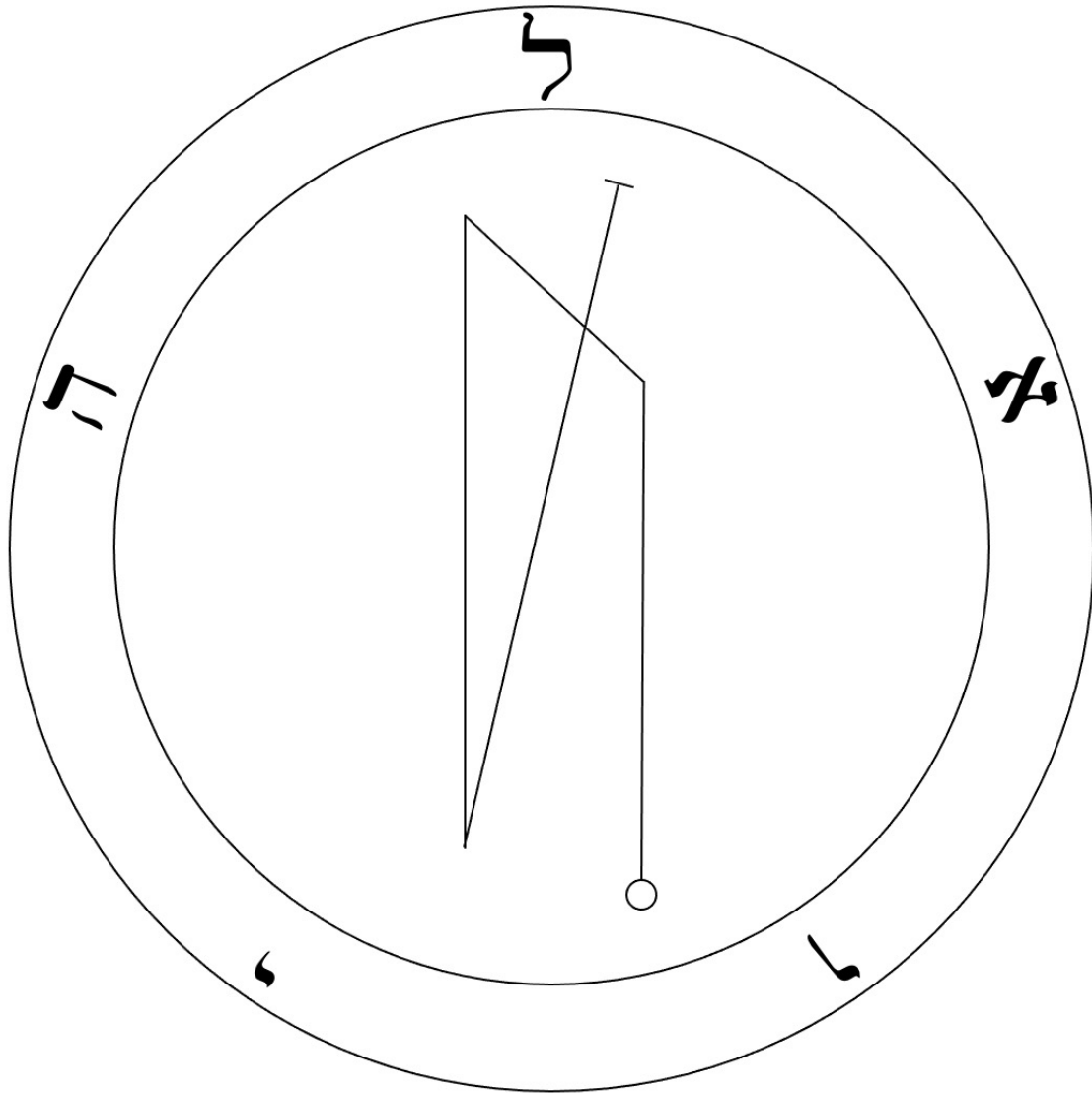

18

כליאל

Caliel

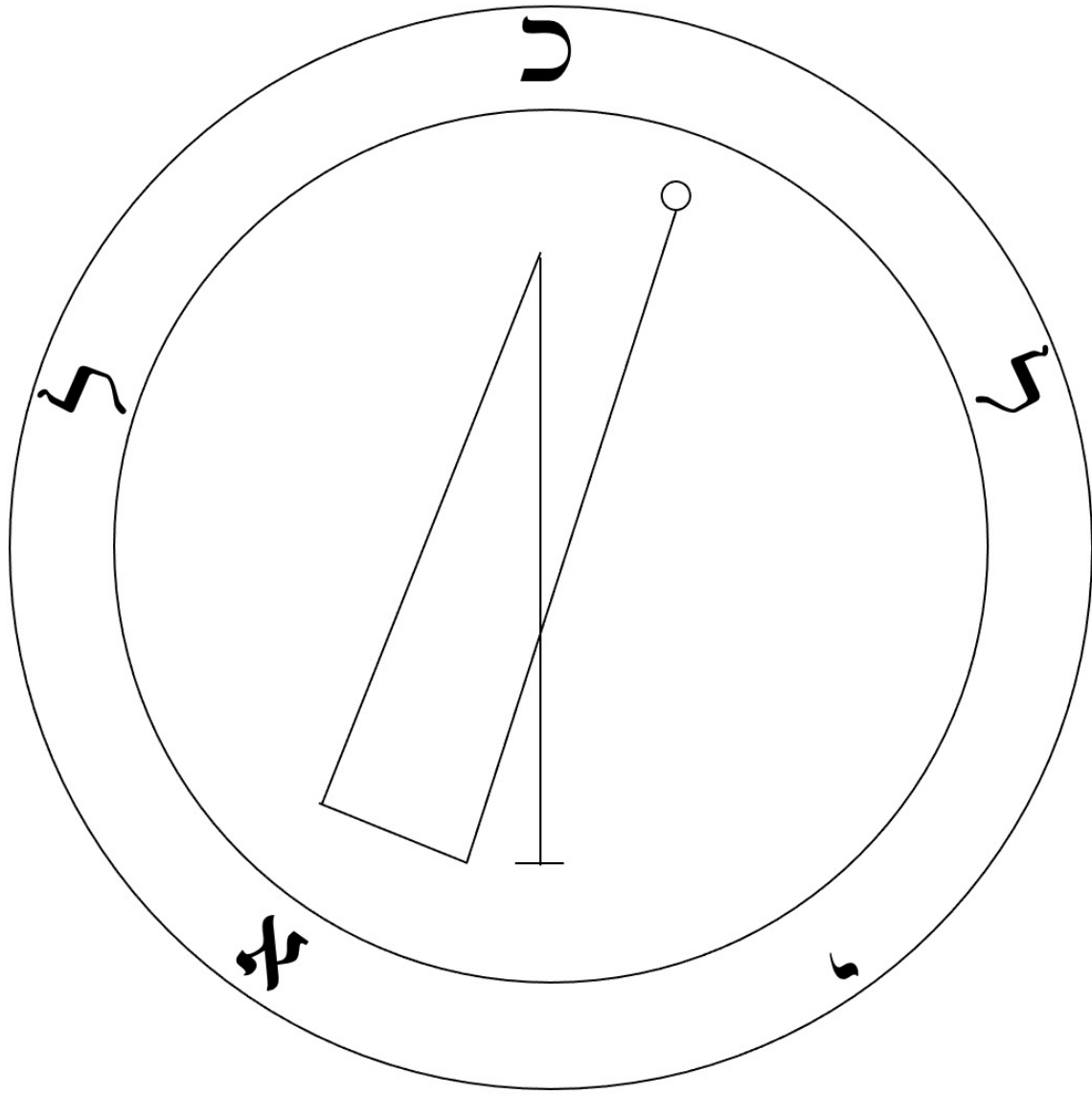

19

לוויה

Leuviah

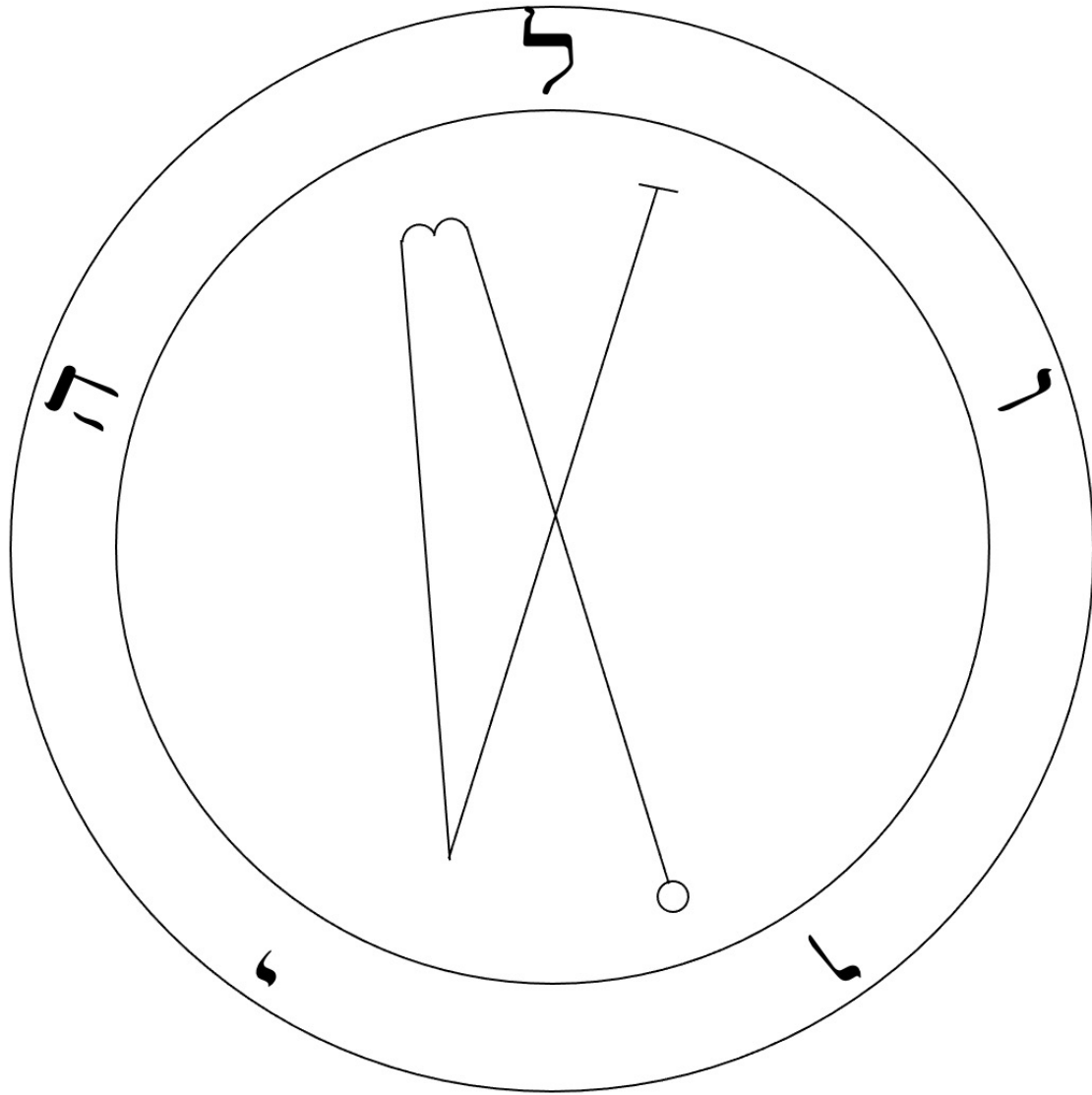

20

פהליה

Pahaliah

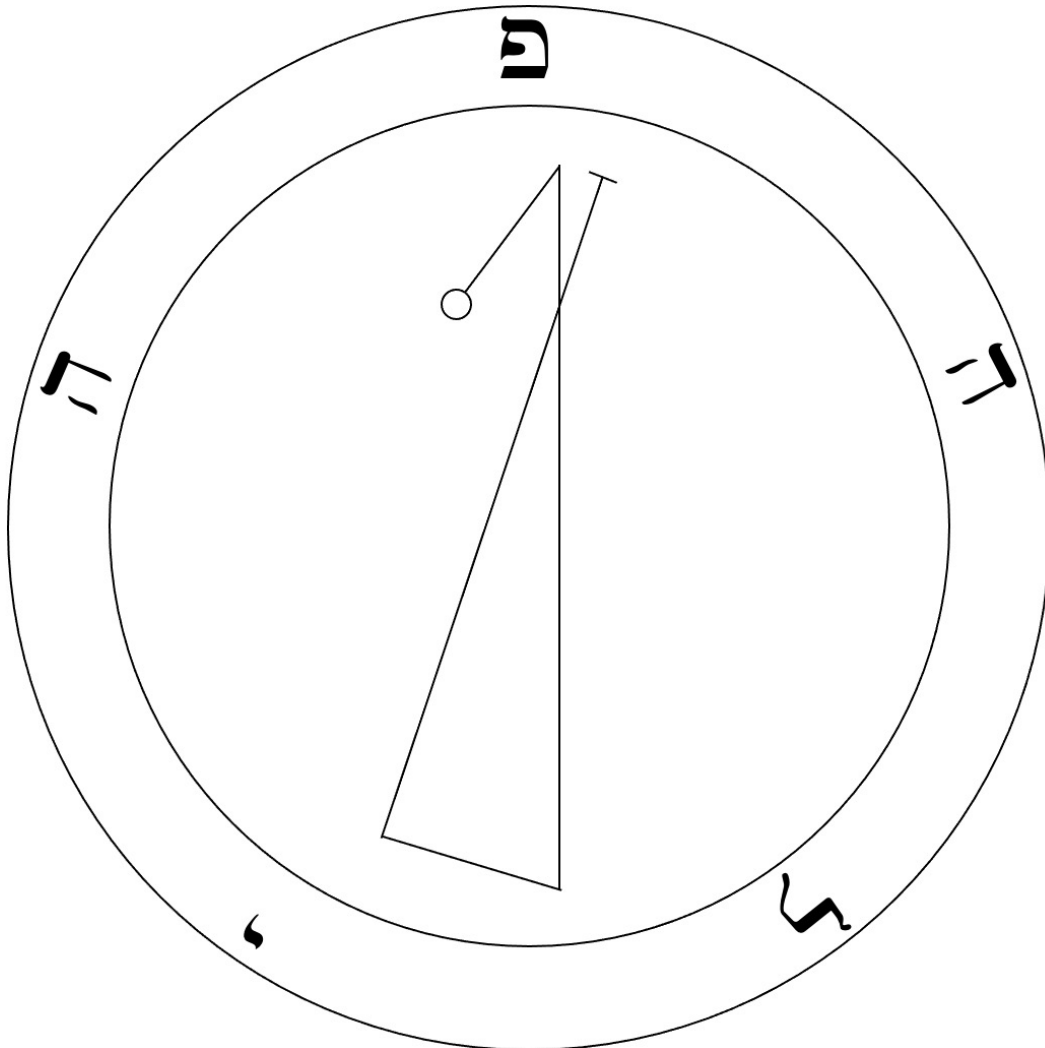

21

נלכאל

Nelchael

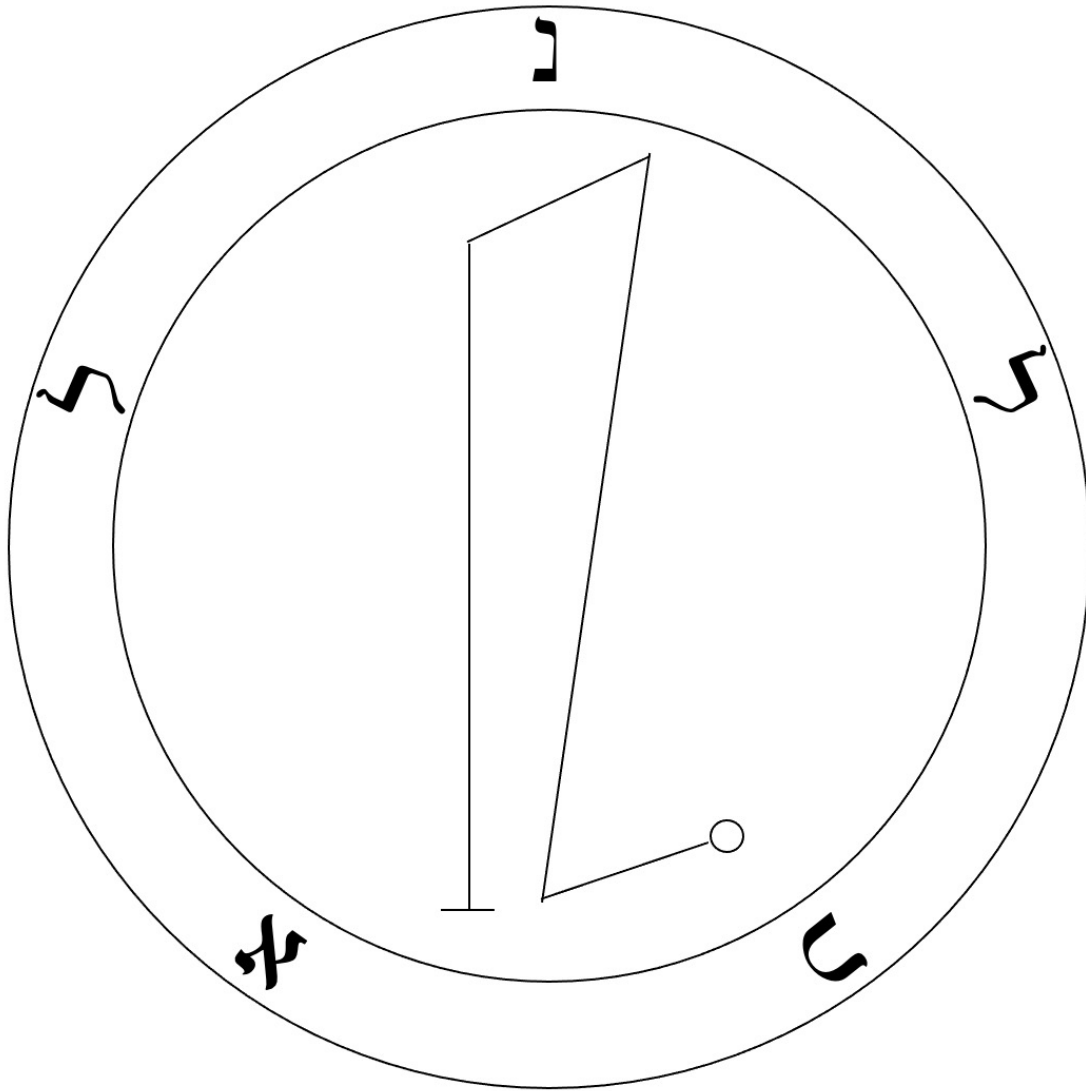

22

יִיֵאל

Ieiaiel

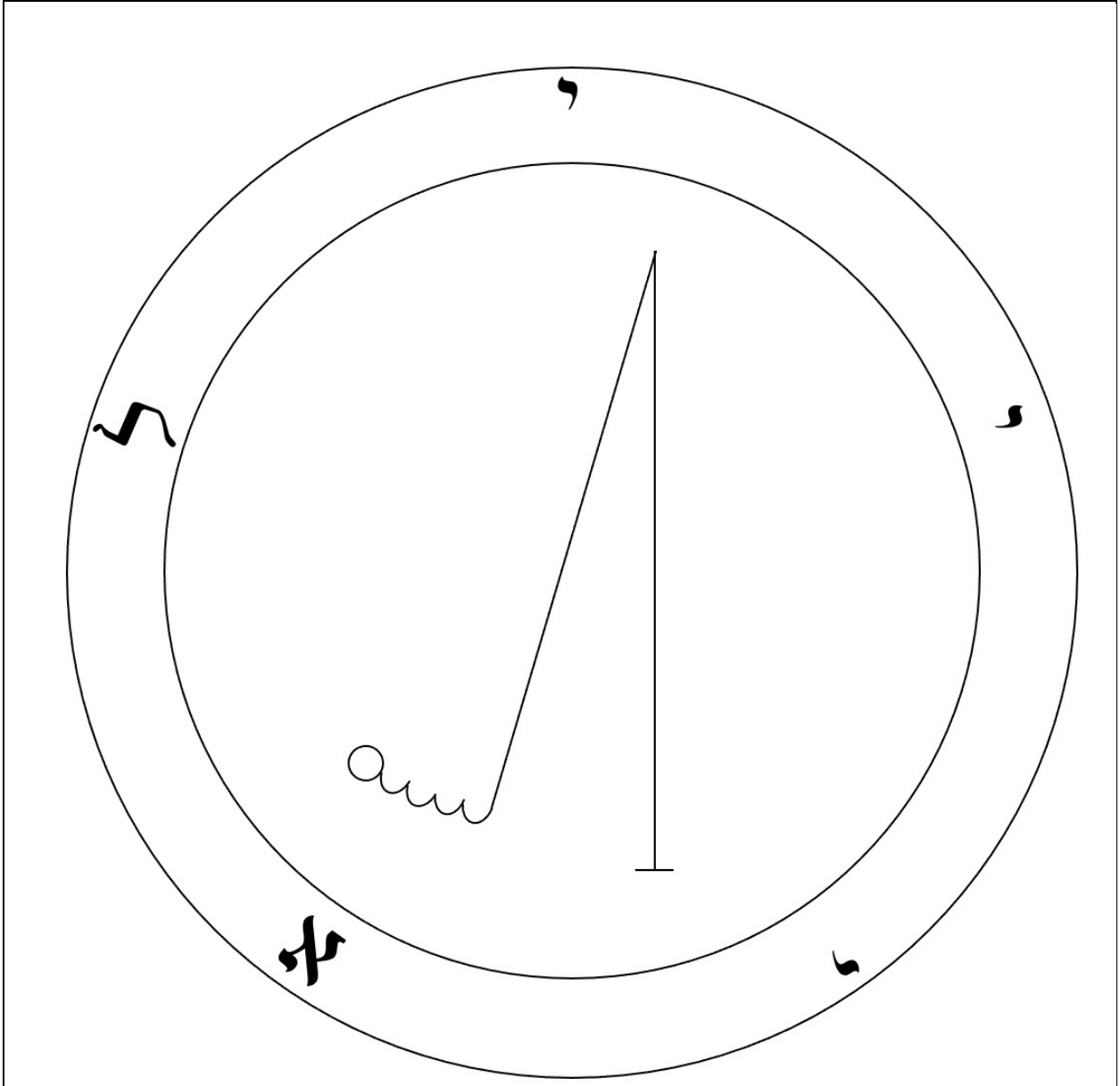

23

מלהאל

Melahel

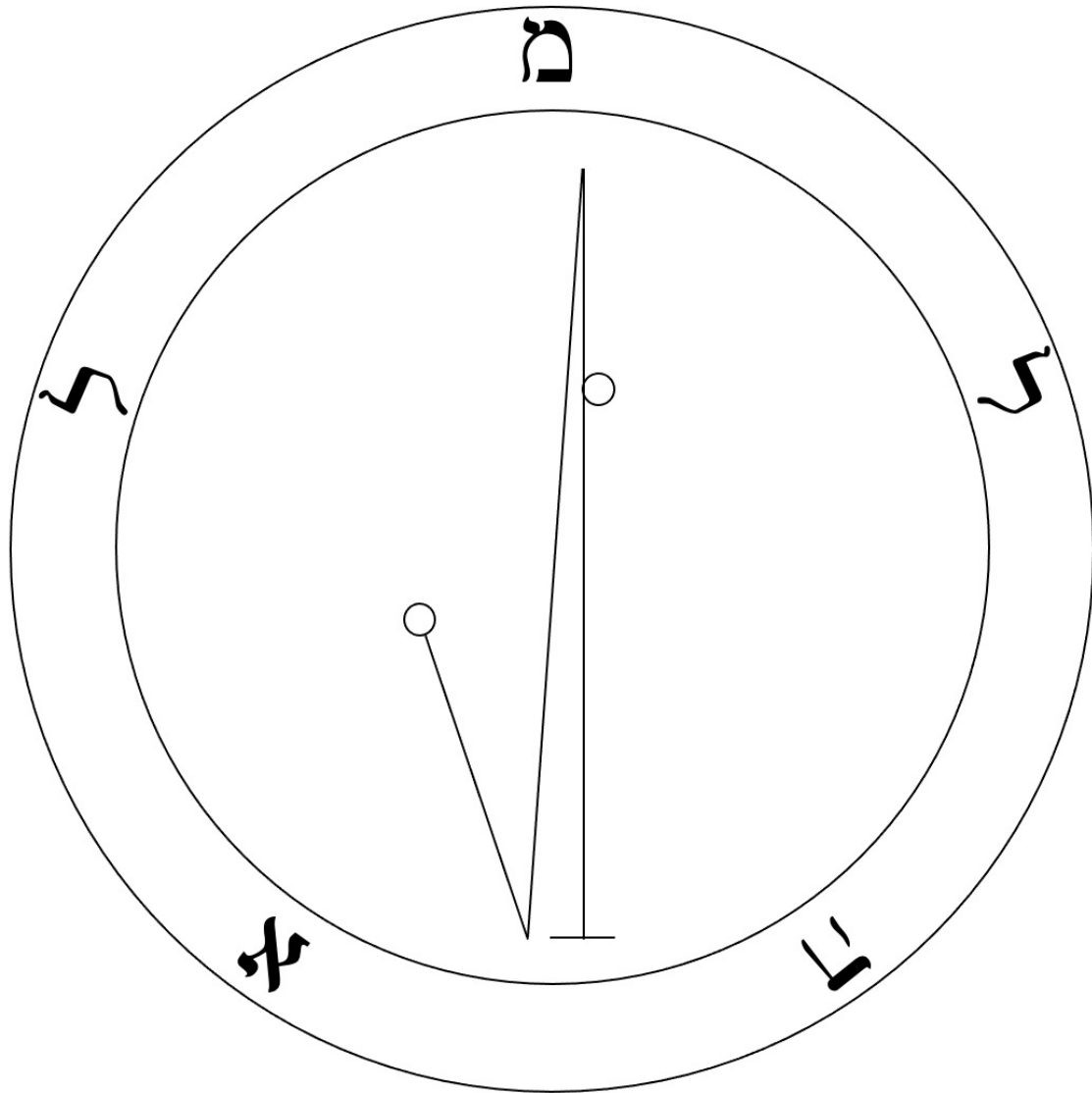

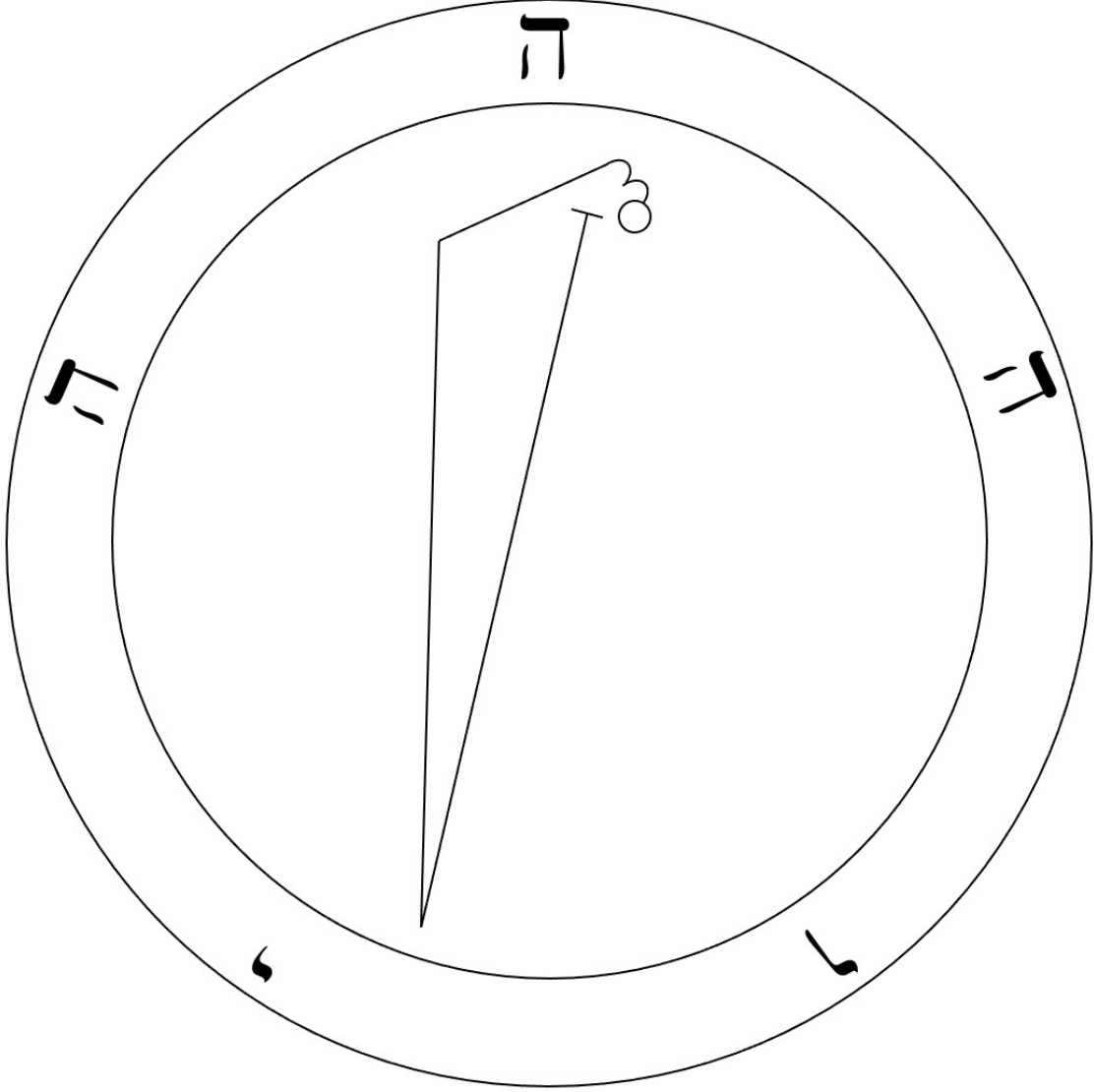

24	ההויה	Hahuiah
 <p>The diagram shows a Rosicrucian sigil for the name Hahuiah. It consists of two concentric circles. The outer circle contains the Hebrew letters ה (top), ה (left), ה (right), and ה (bottom) positioned at the 12, 9, 3, and 6 o'clock positions respectively. The inner circle contains a central geometric figure: a vertical line with a horizontal bar at the top, forming a T-shape. From the top-right corner of this T-shape, a diagonal line extends to the right and then curves upwards to meet the inner circle. At this point of contact, there is a small circle with a horizontal line passing through its center, resembling a stylized '3' or a specific magical symbol.</p>		

25

נתהיה

Nith-Haiah

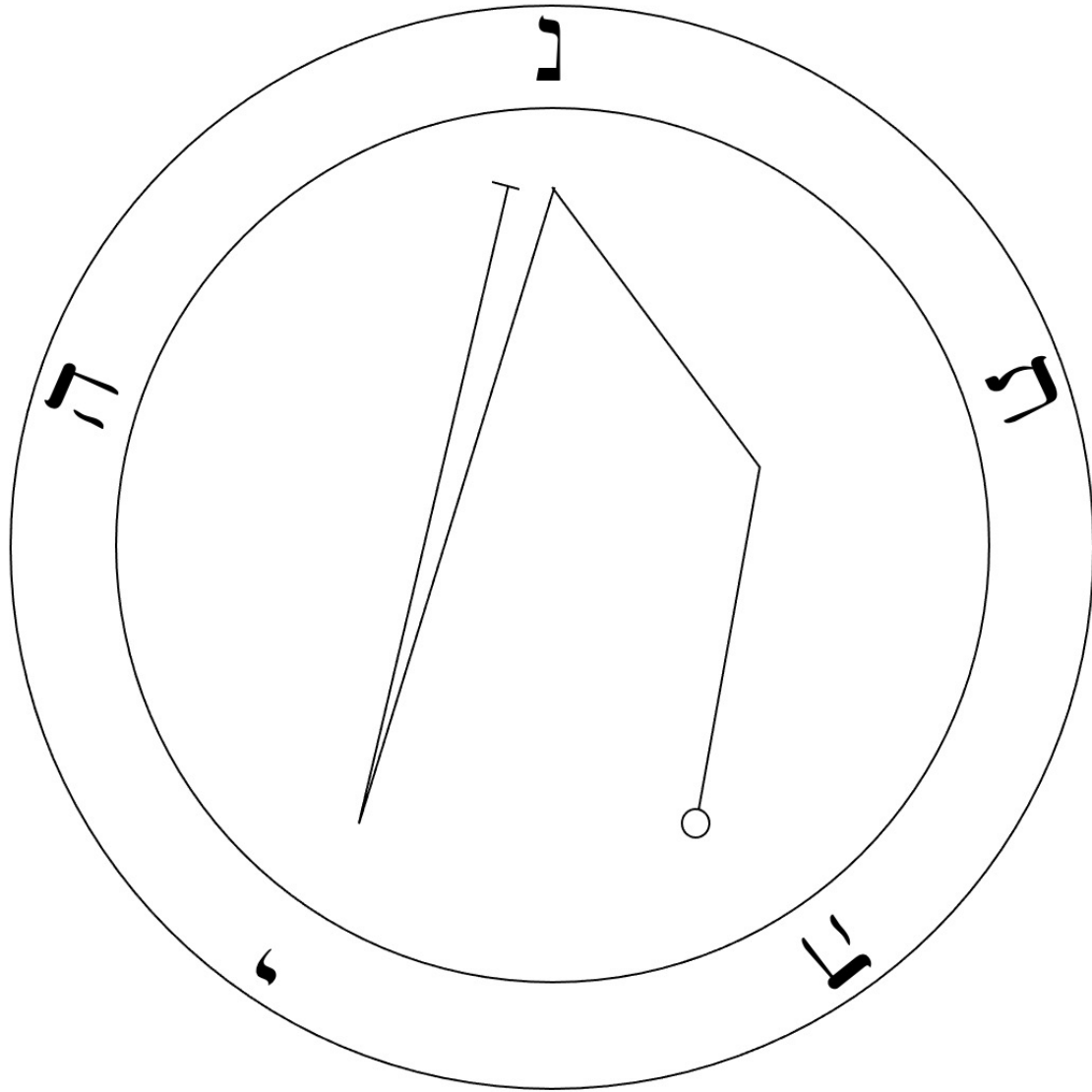

26	האיה	Haaiah
----	------	--------

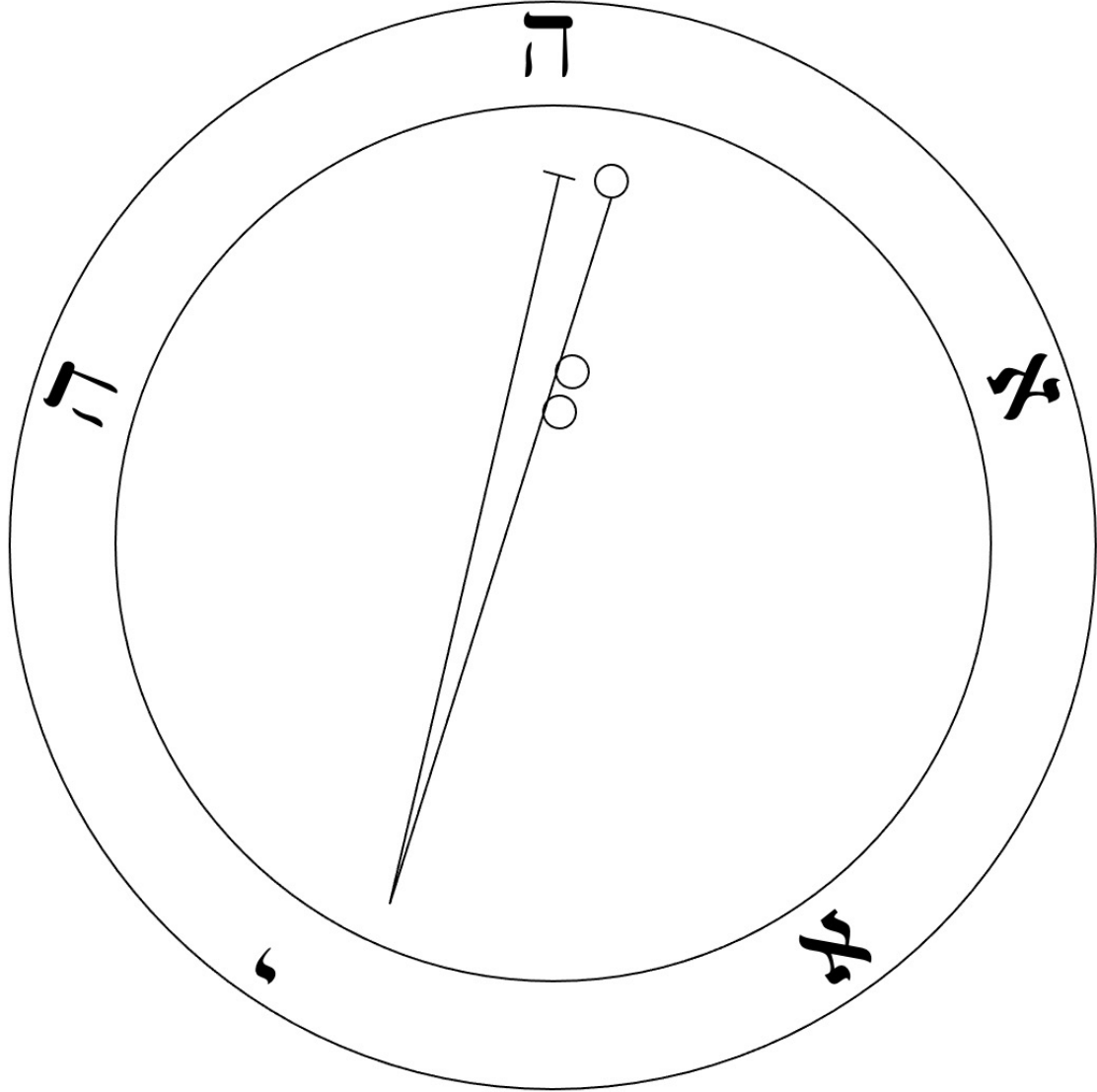
The diagram features a square frame containing two concentric circles. The outer circle is inscribed with the Hebrew letters 'ה' at the top, 'א' on the right, 'י' at the bottom, and 'ה' on the left. The inner circle contains a central sigil consisting of two parallel lines that converge to a point at the bottom. The upper line is shorter and ends in a small circle. The lower line is longer and passes through two small circles before ending in a larger circle at the top.

27	ירתאל	Ierathel
 <p>The diagram features a square frame containing two concentric circles. The outer circle is inscribed with four Hebrew characters: י (top), ו (right), ת (bottom), and א (left). Inside the circles is a geometric sigil consisting of a vertical line with a short horizontal base at the bottom. A horizontal line extends from the vertical line to the right, ending in a triangle pointing right. A diagonal line extends from the top vertex of this triangle down to a small circle in the lower-left quadrant.</p>		

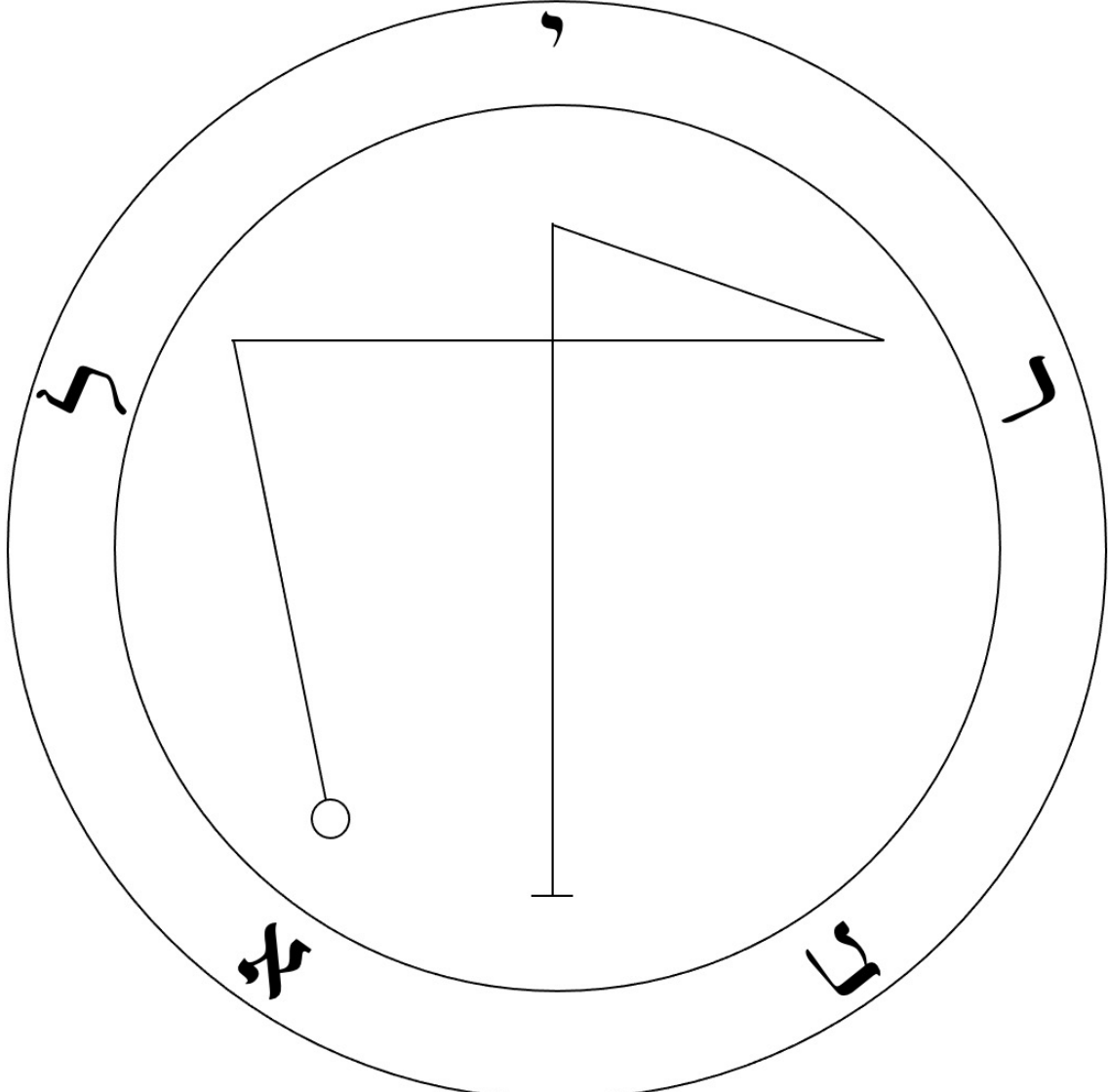
28

שאהיה

Seheiah

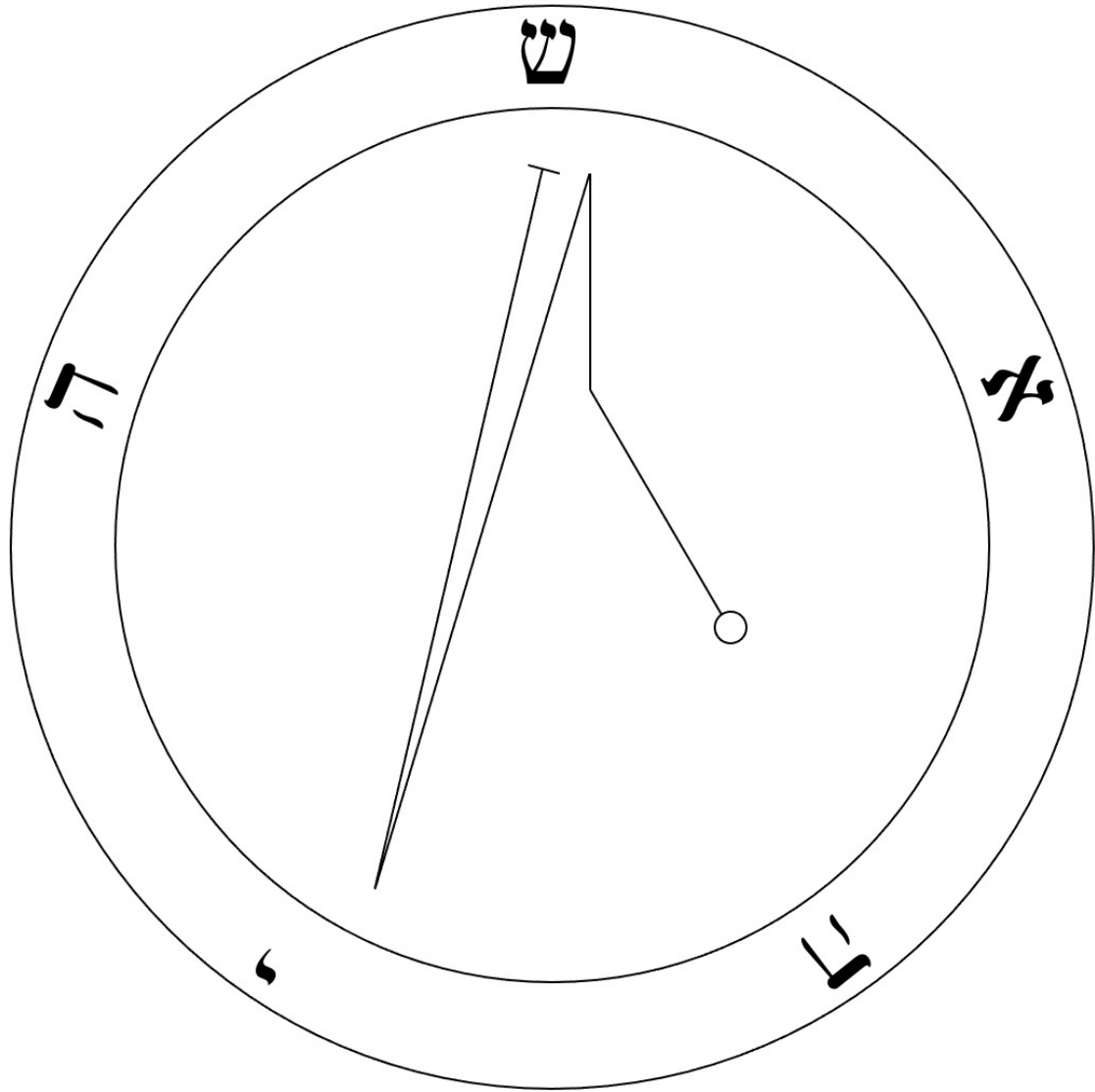

29

ריאל

Reiel

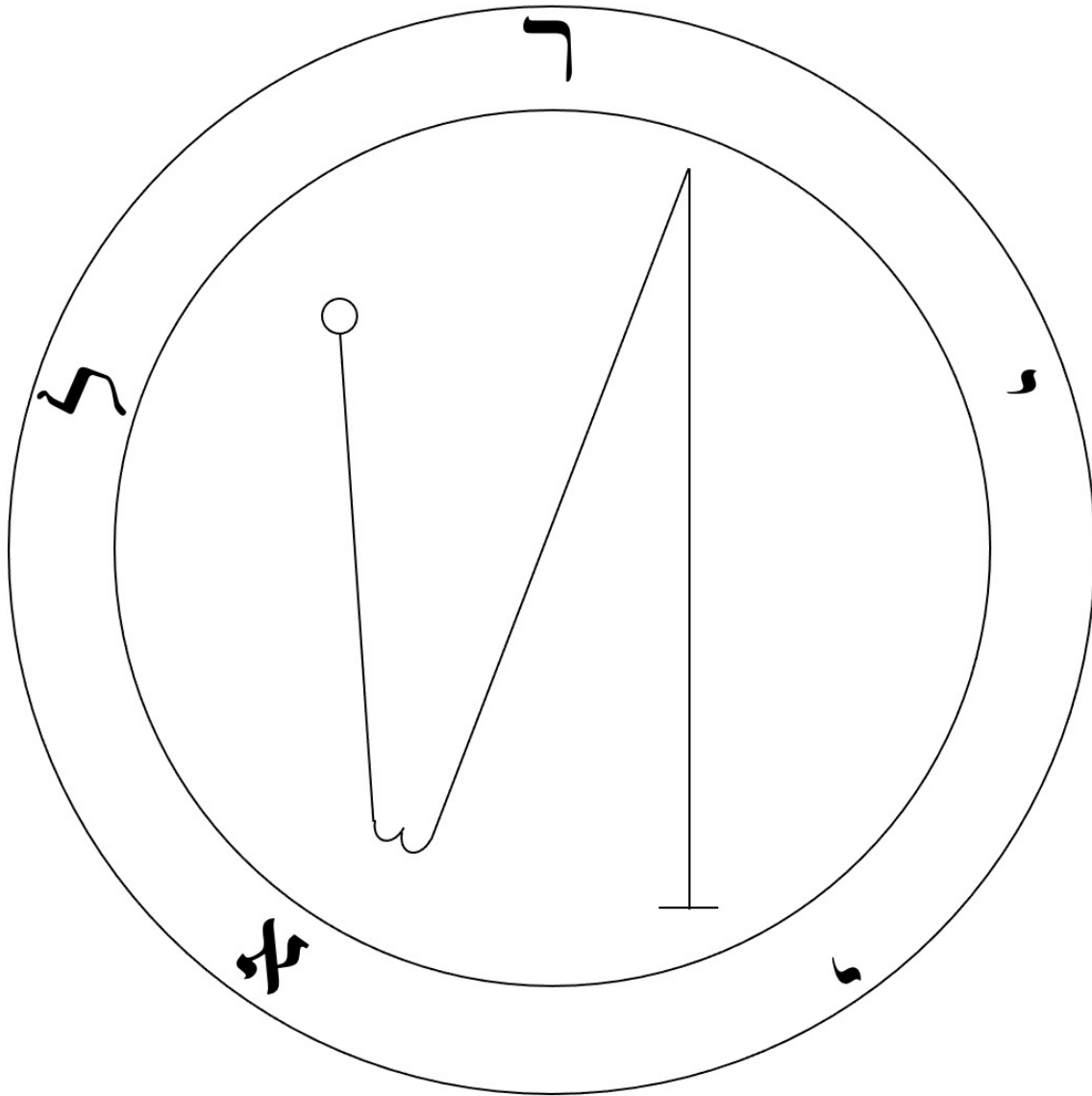

30

ומאאל

Omael

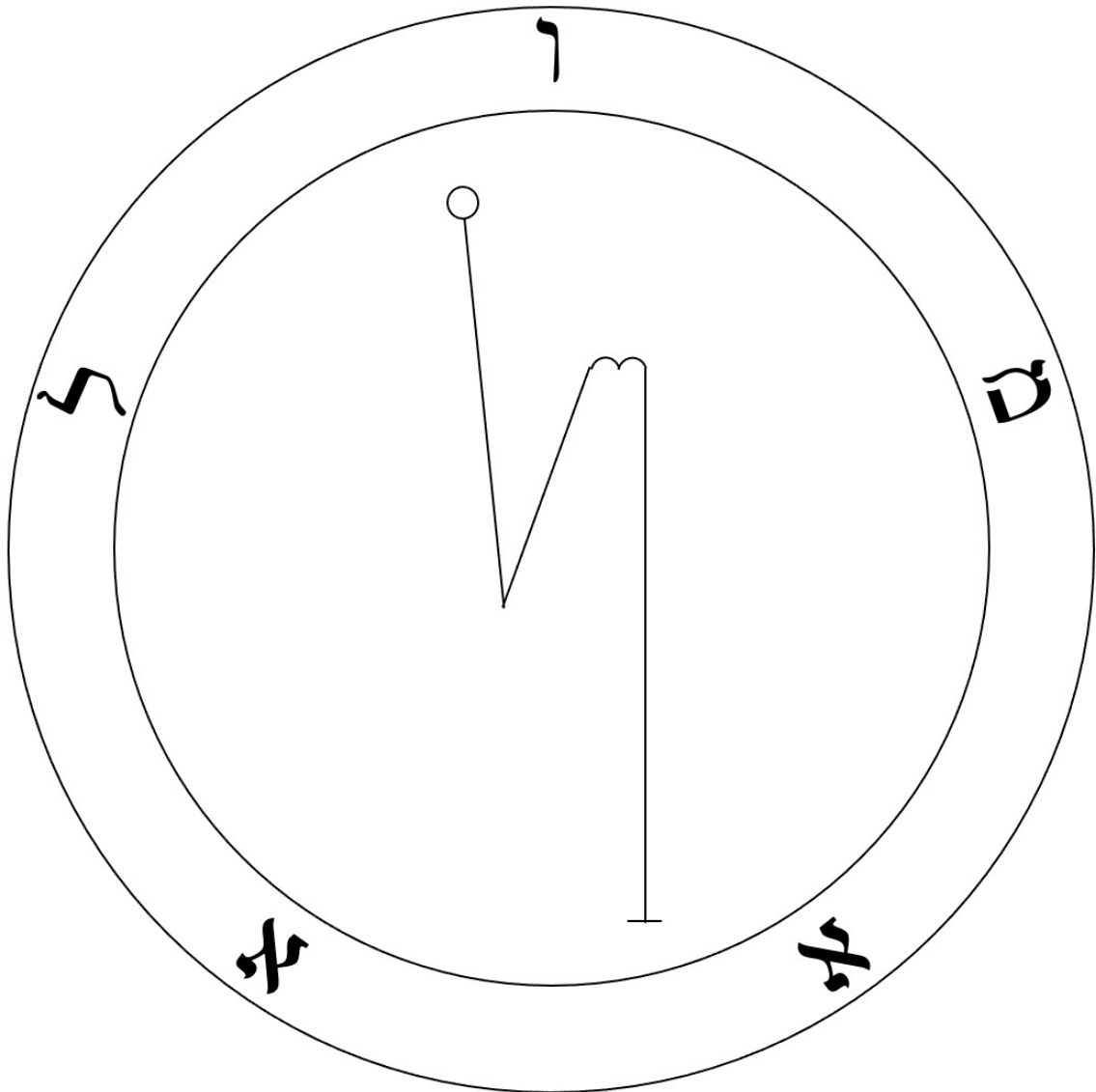

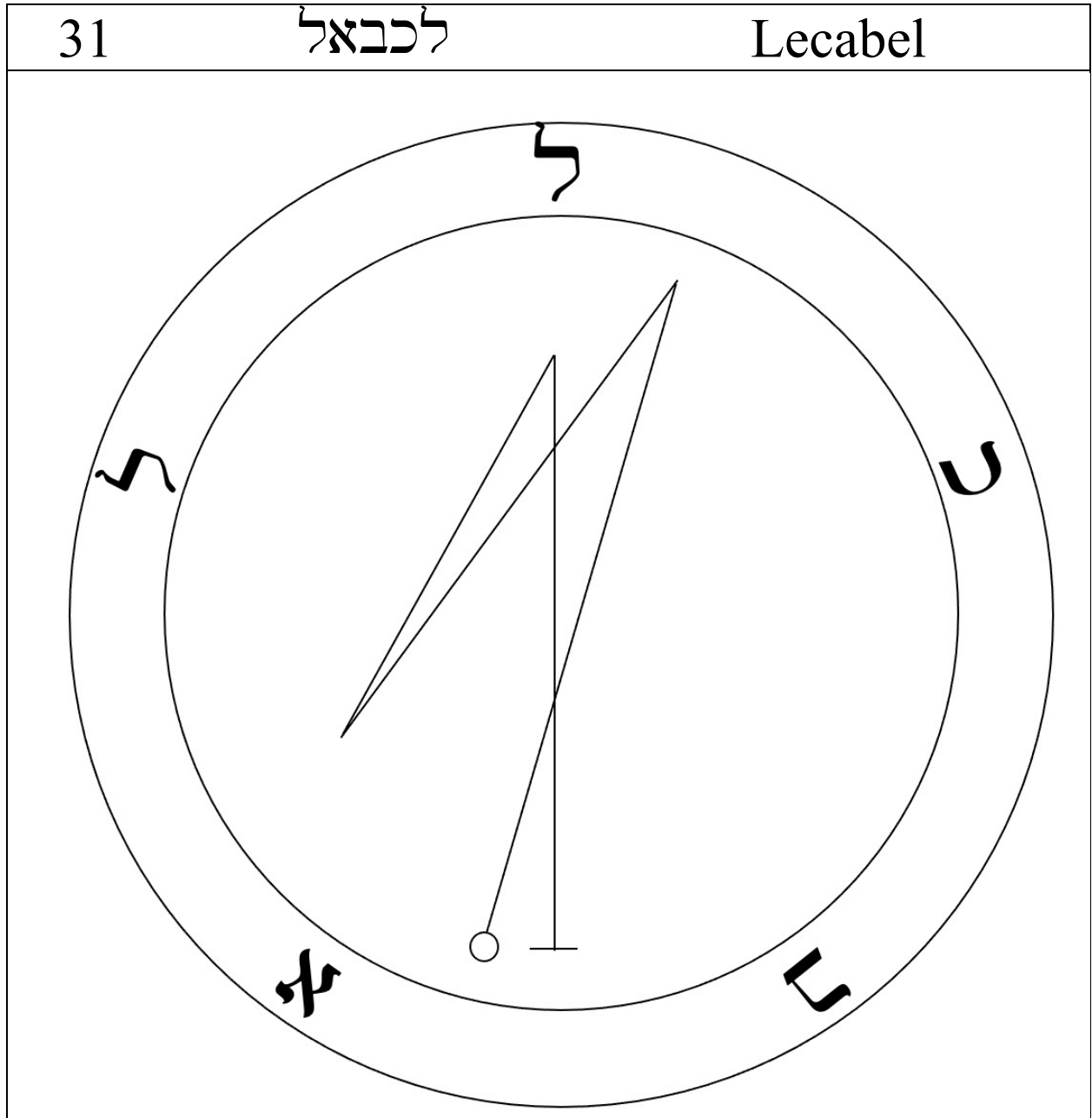



32

ושריה

Vasiariah

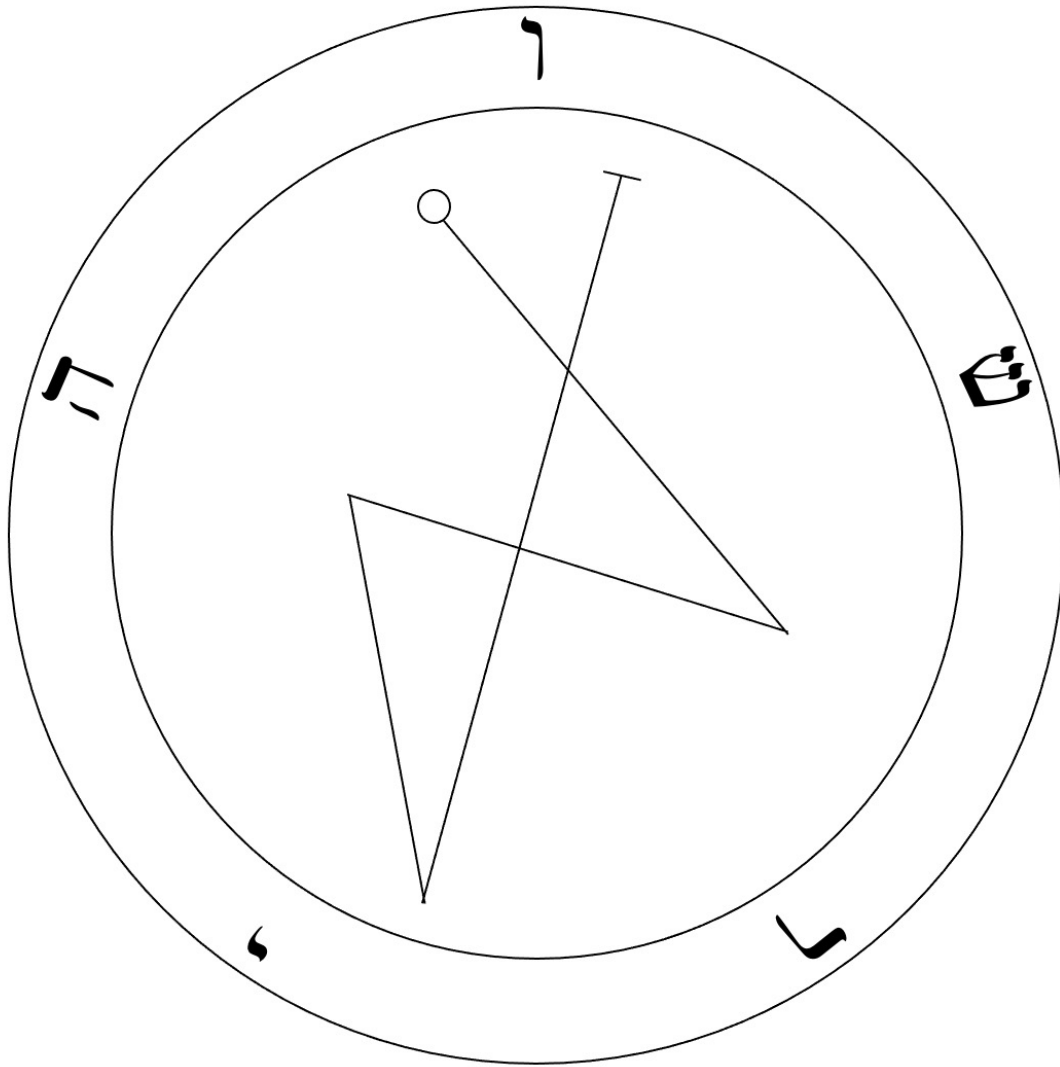

33

יהויה

Iehuah

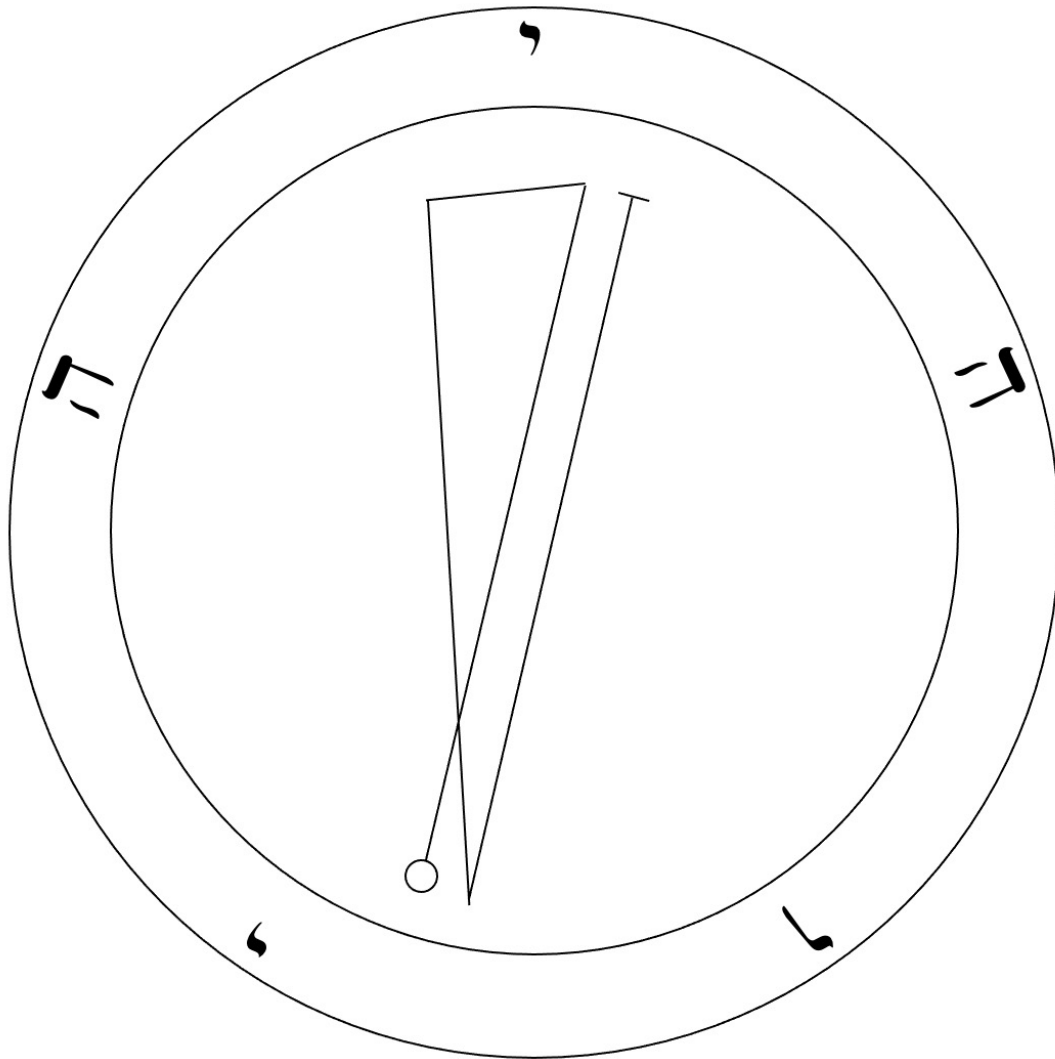

34

לההיה

Lehahiah

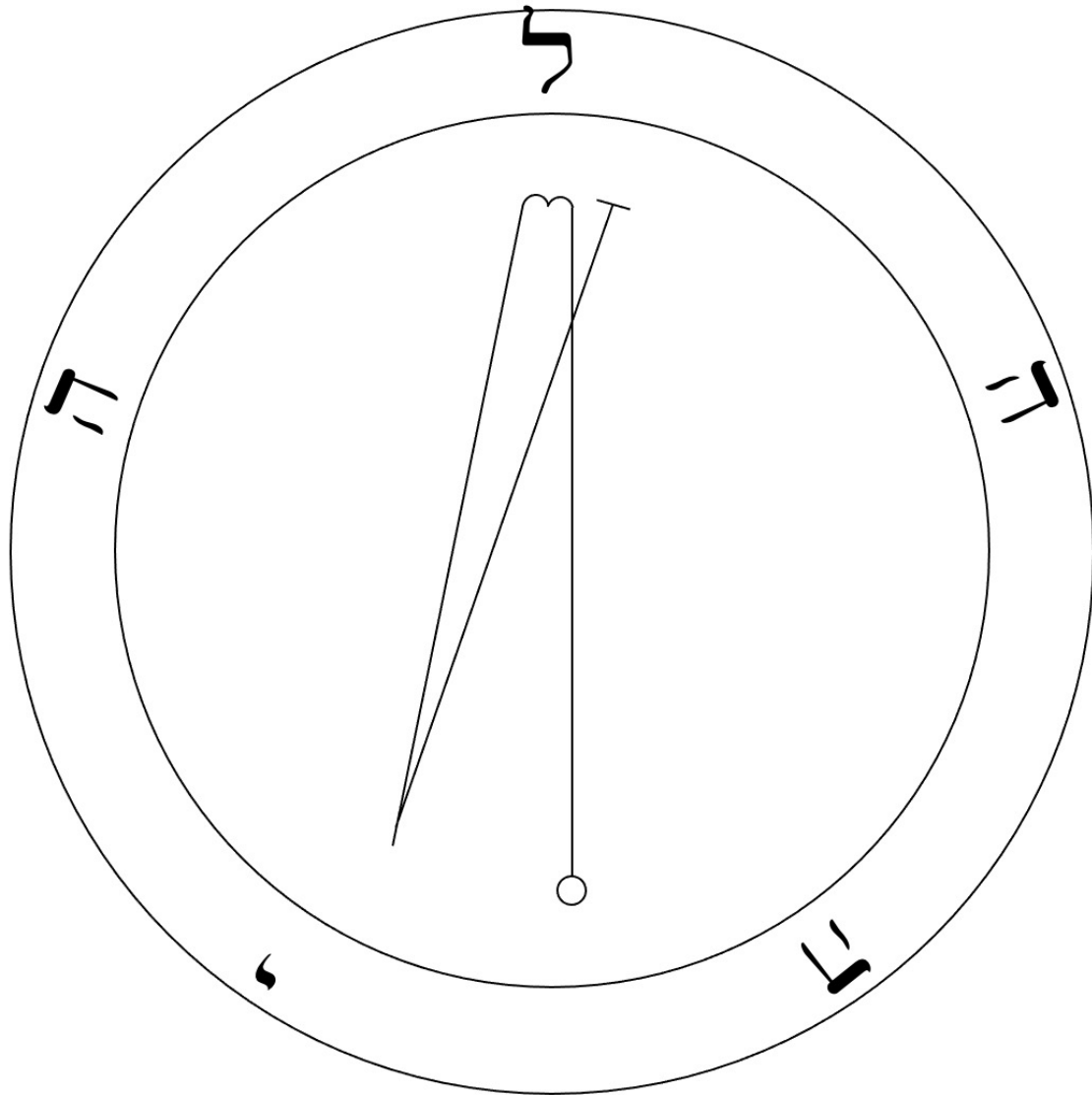

35

כוקיה

Chavakiah

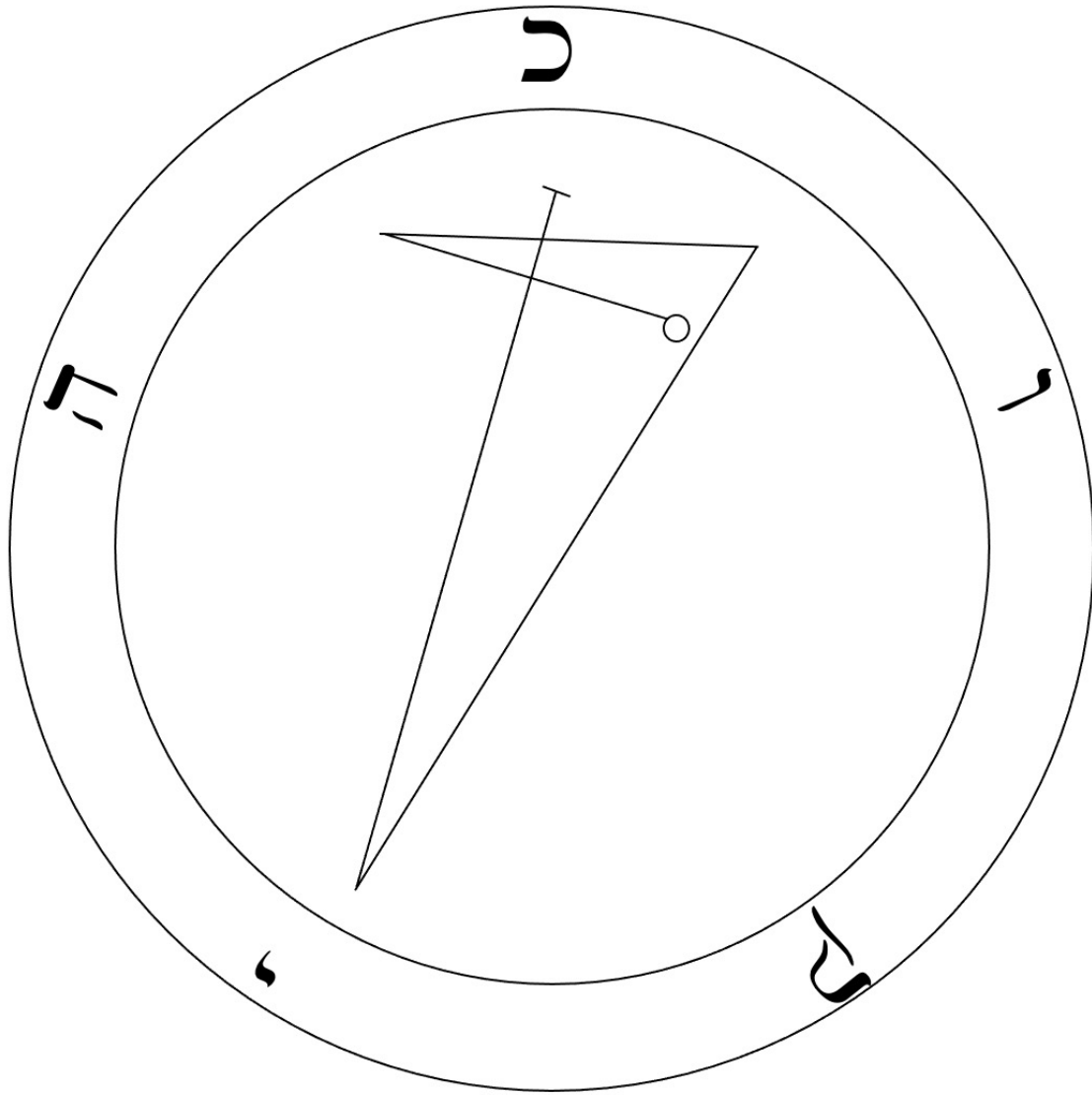

36

מנדאל

Menadel

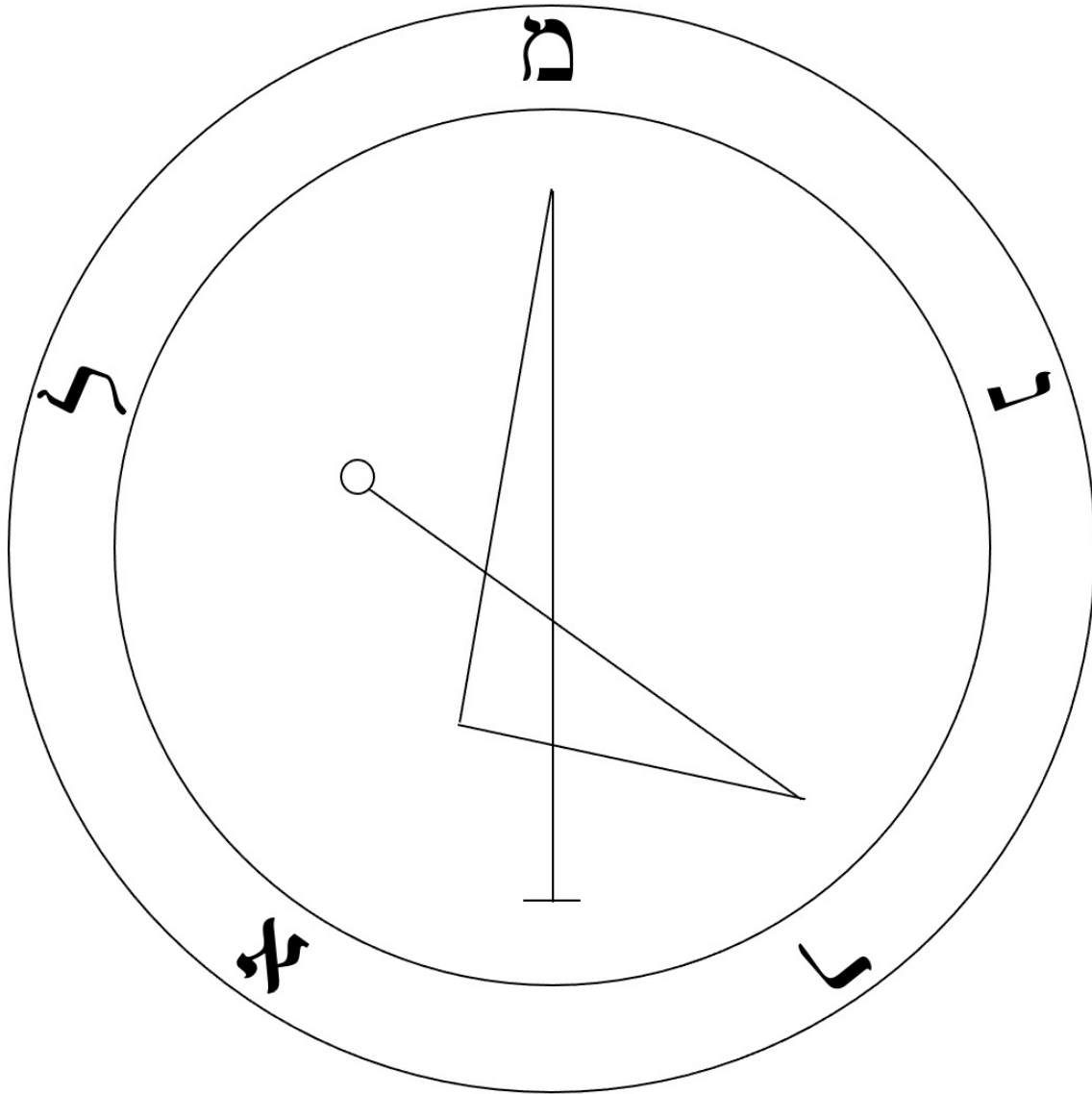

37

אניאל

Aniel

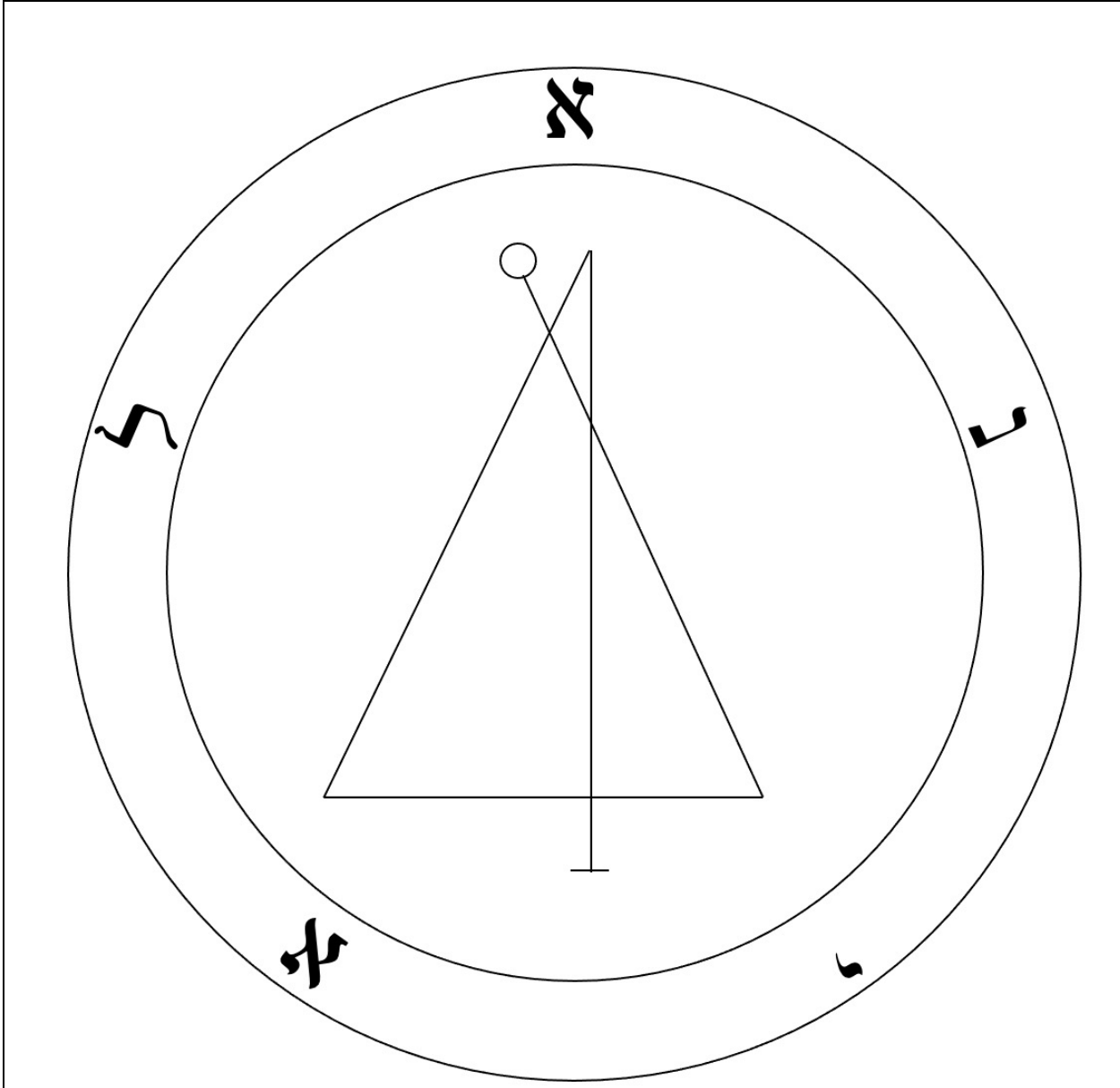

38

העמיה

Haamiah

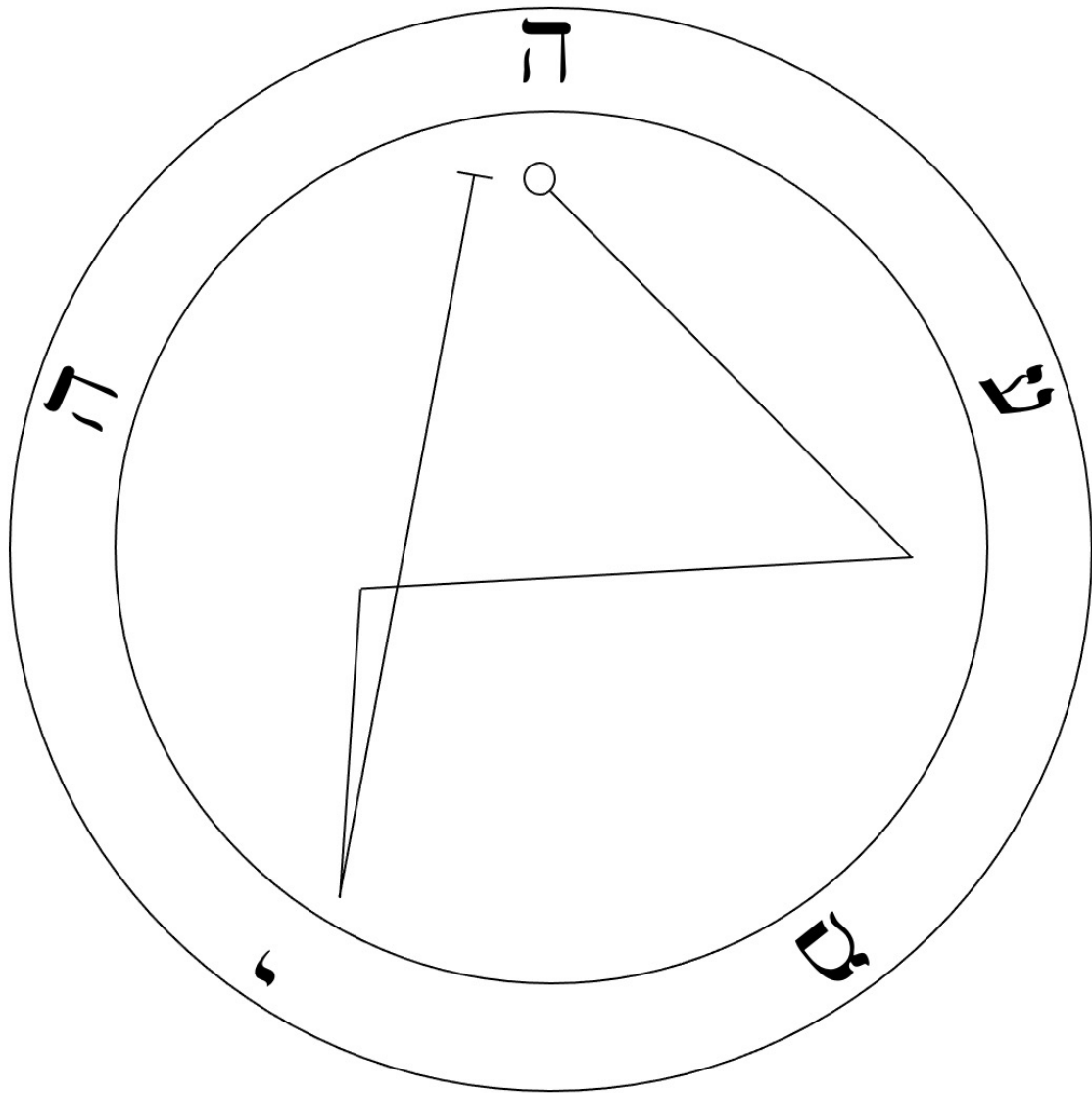

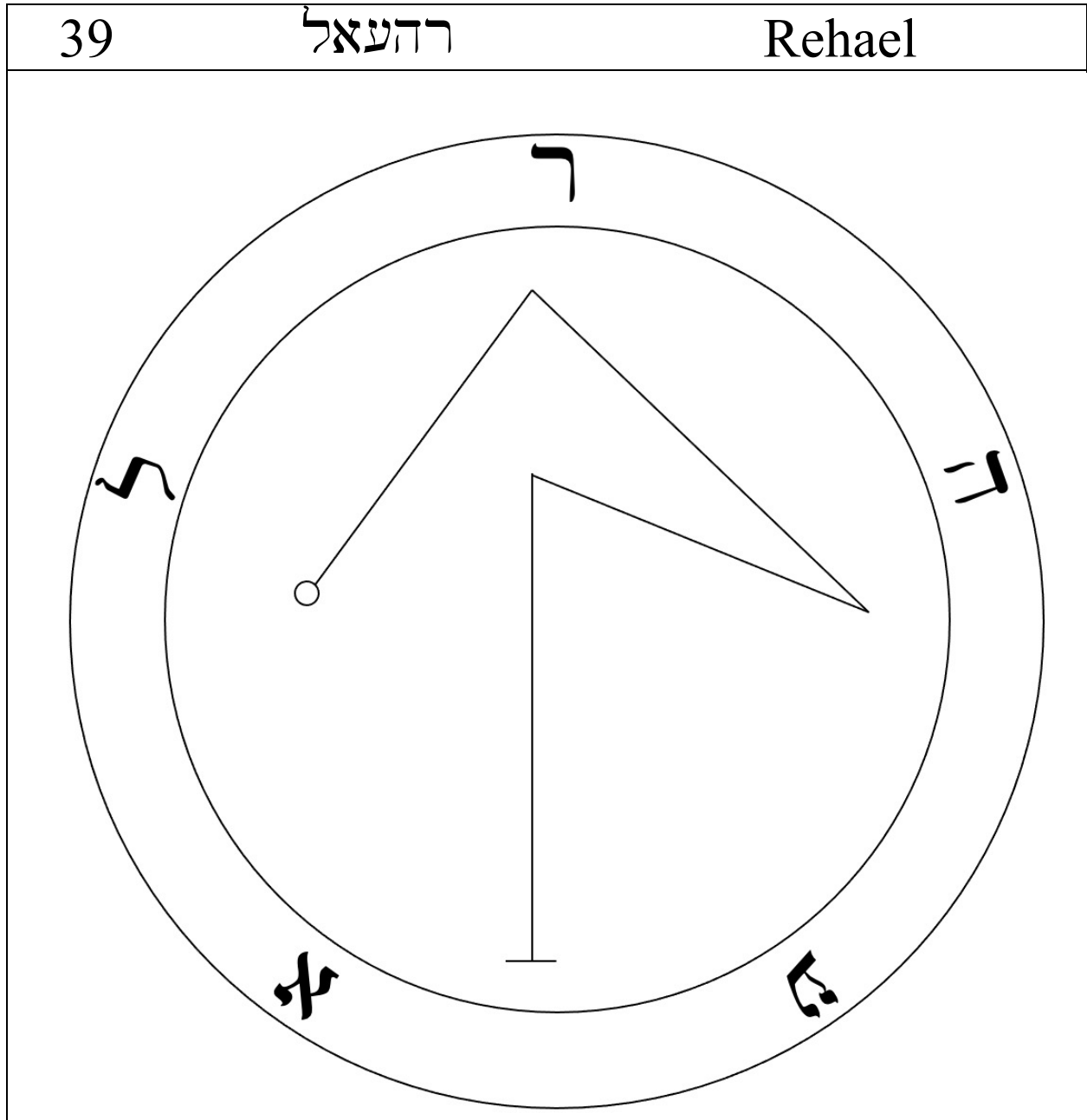



40

יִזְעַל

Ieizel

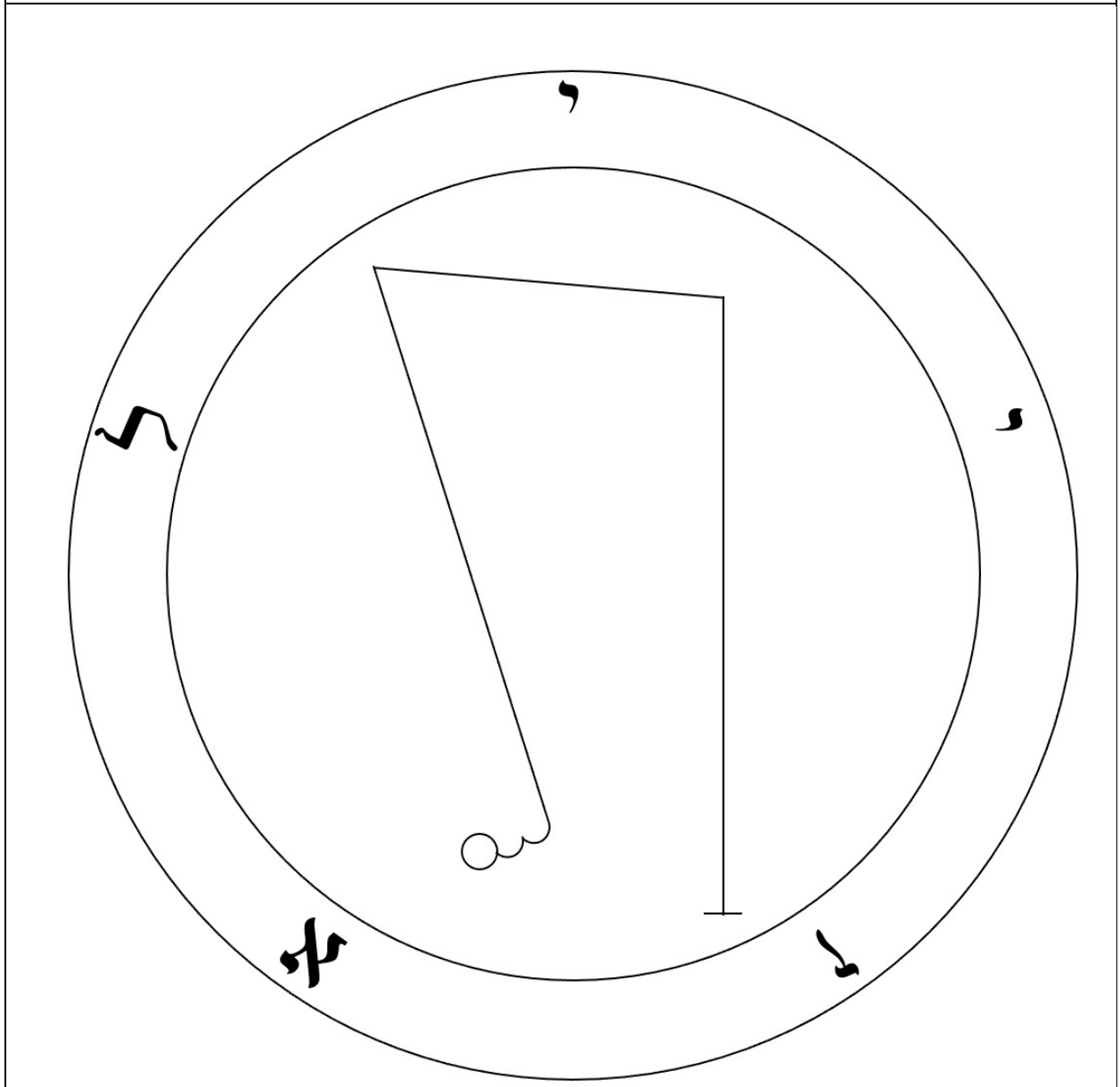

41

הההאל

Hahahel

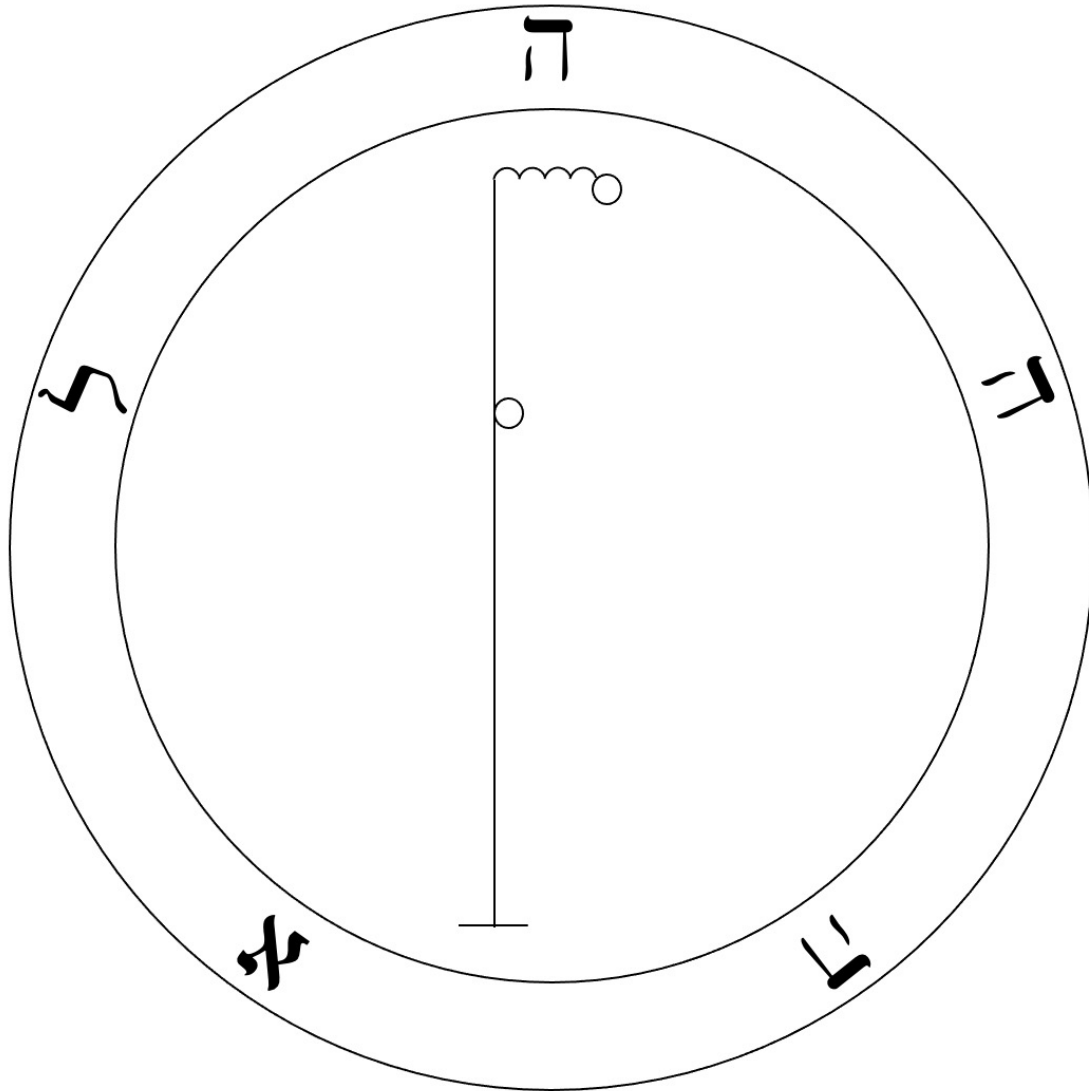

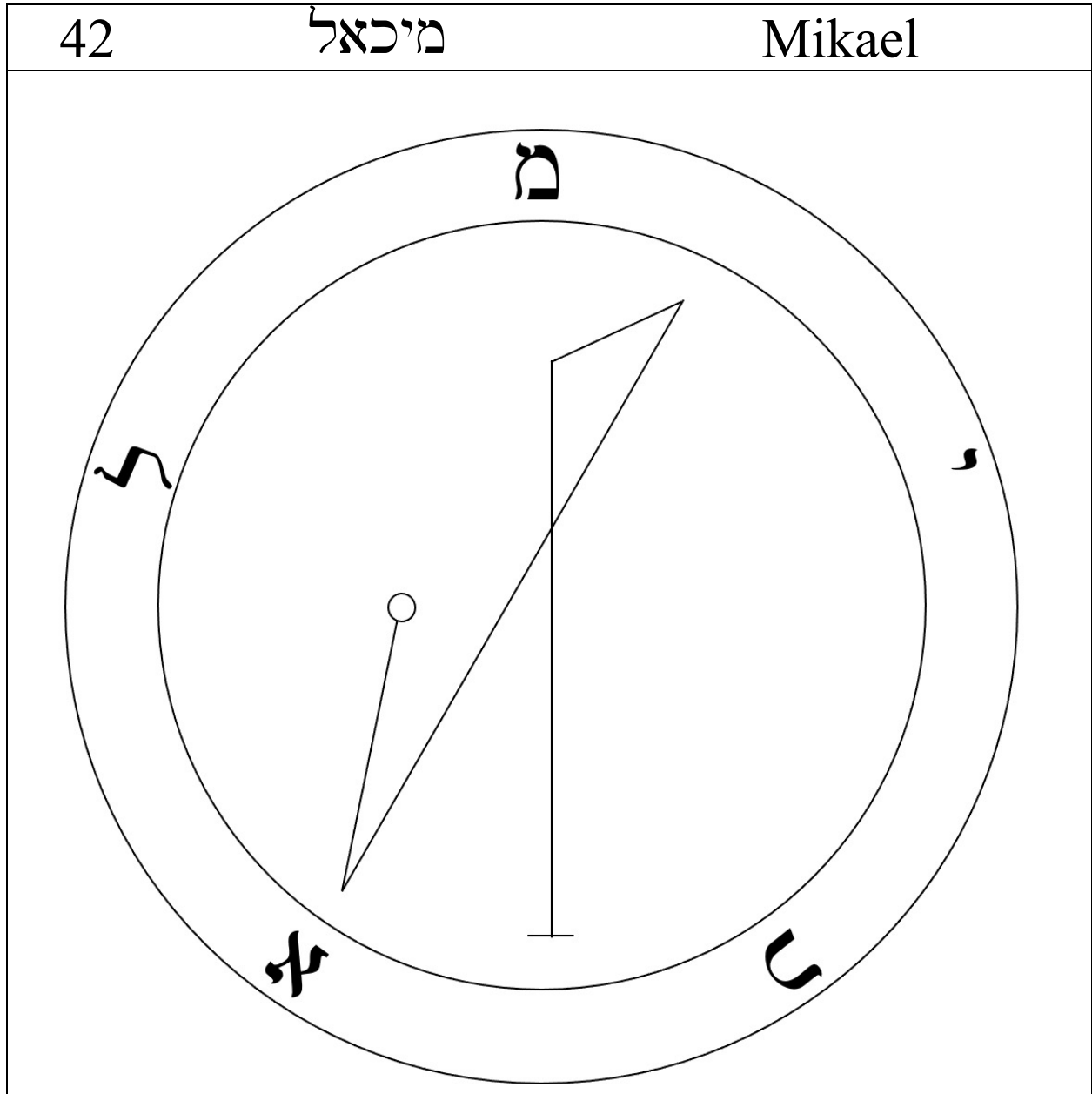

43

ווליה

Veuliah

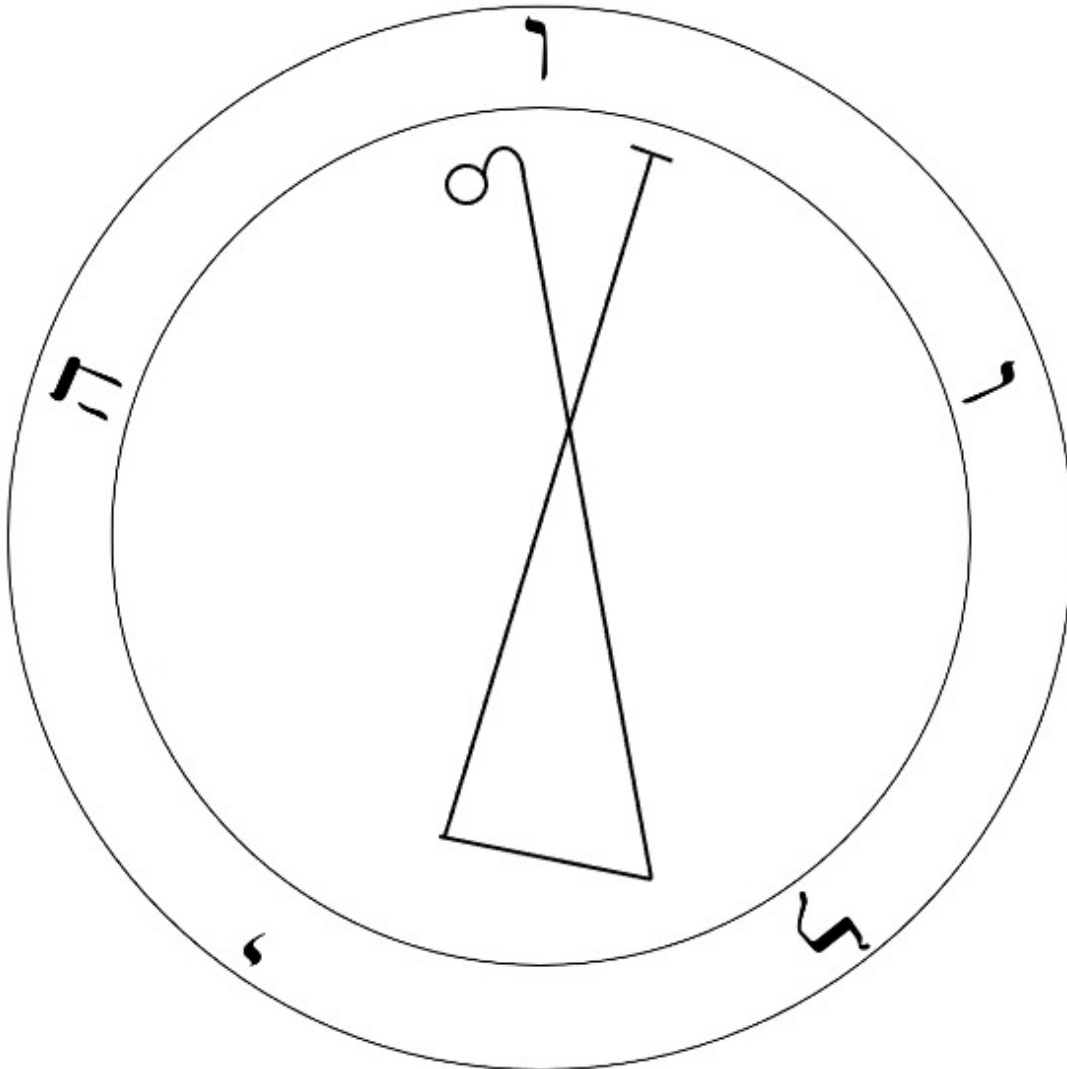

44

יֵלֵהִיָּה

Ielahiah

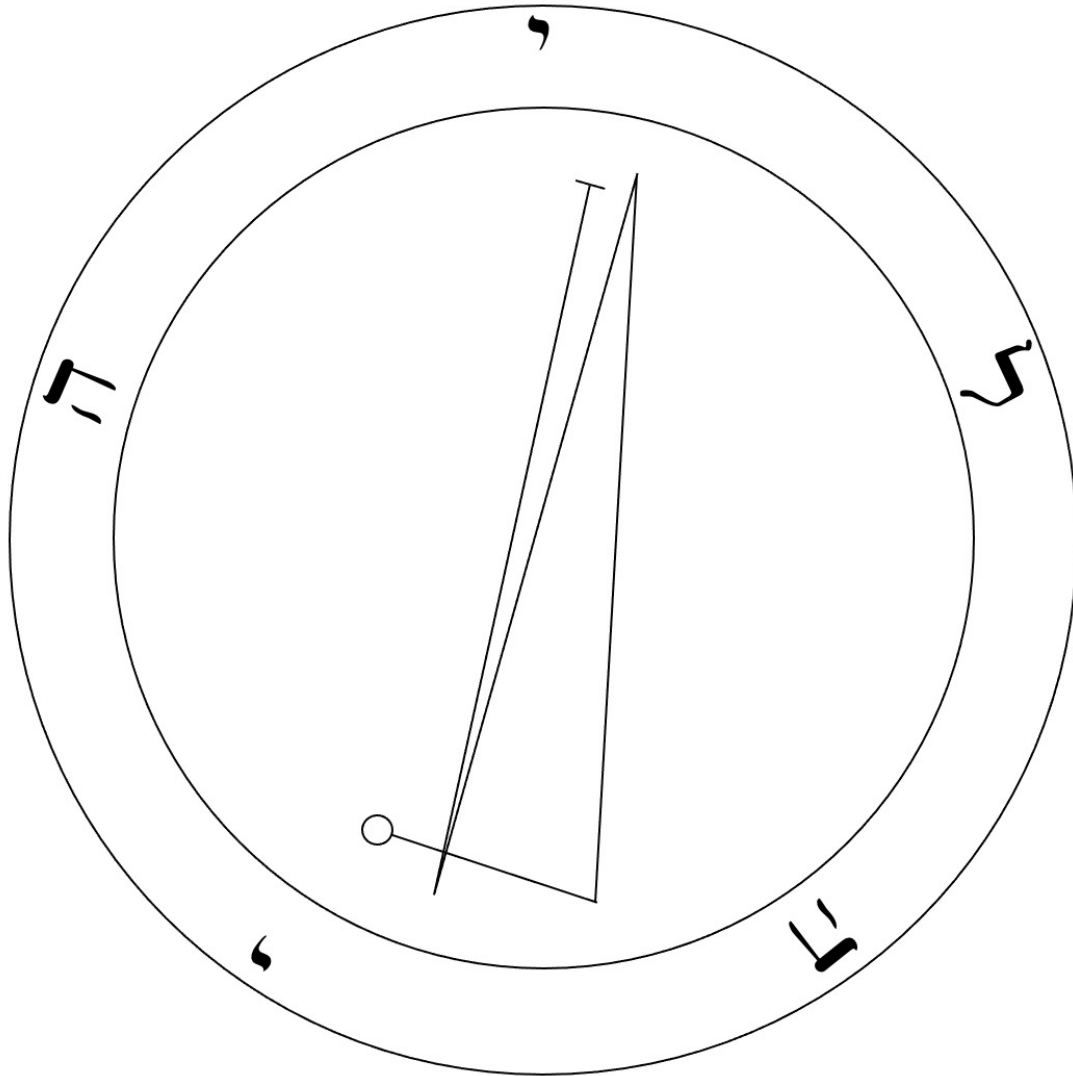

45

סאליה

Sealiah

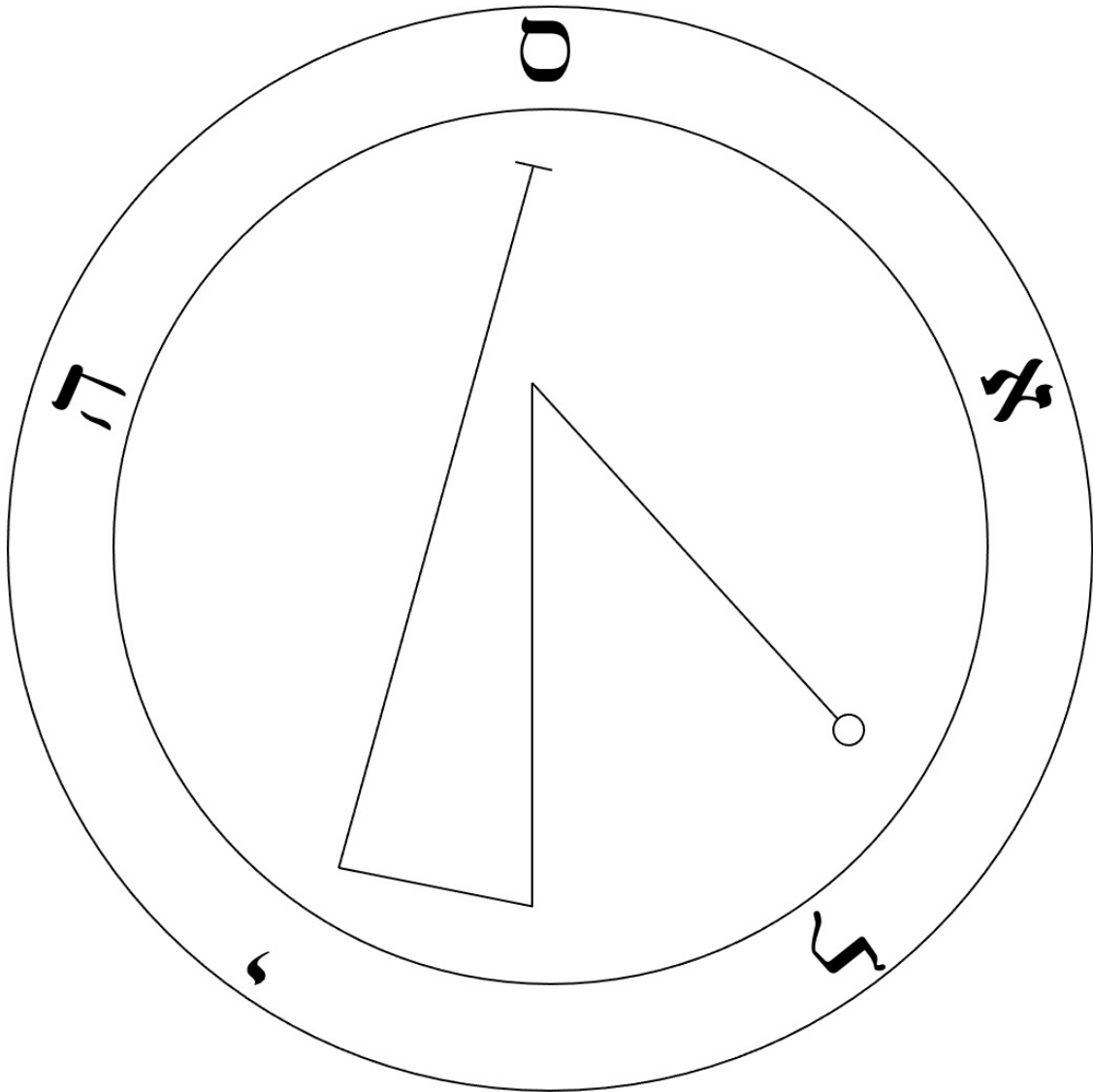

46

עריאל

Ariel

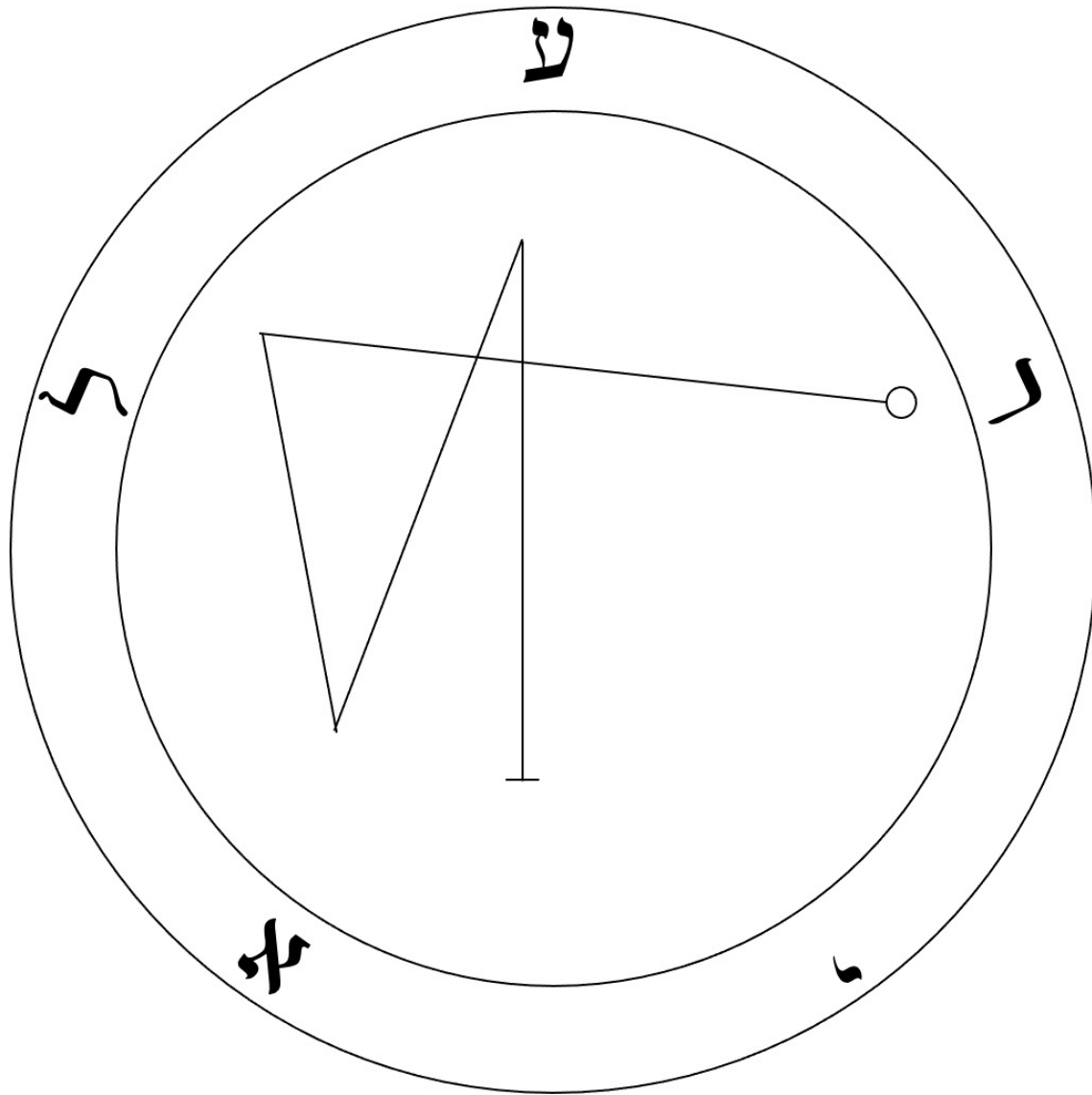

47

עשליה

Asaliah

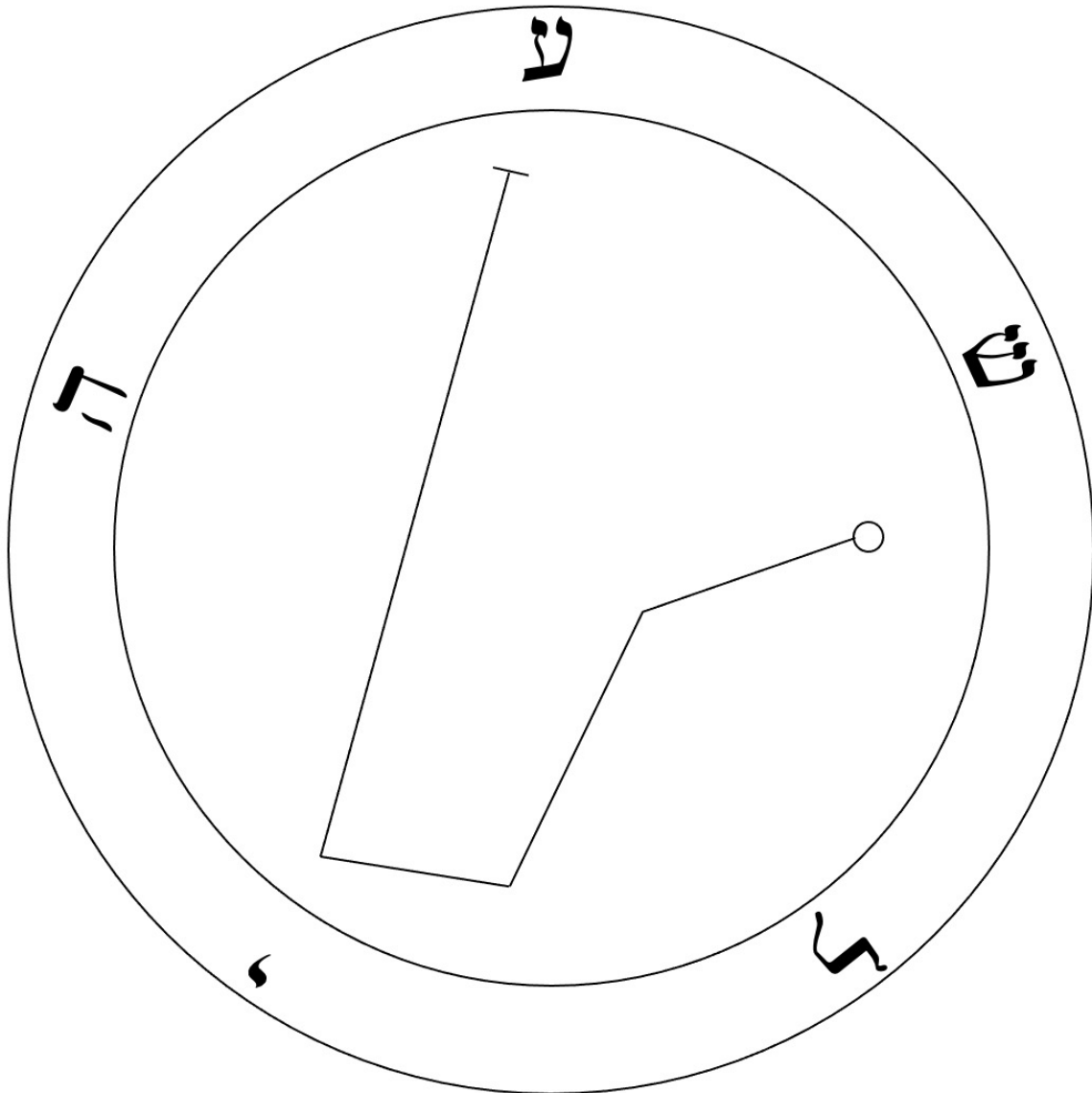



48

מִיְהוָה

Mihael

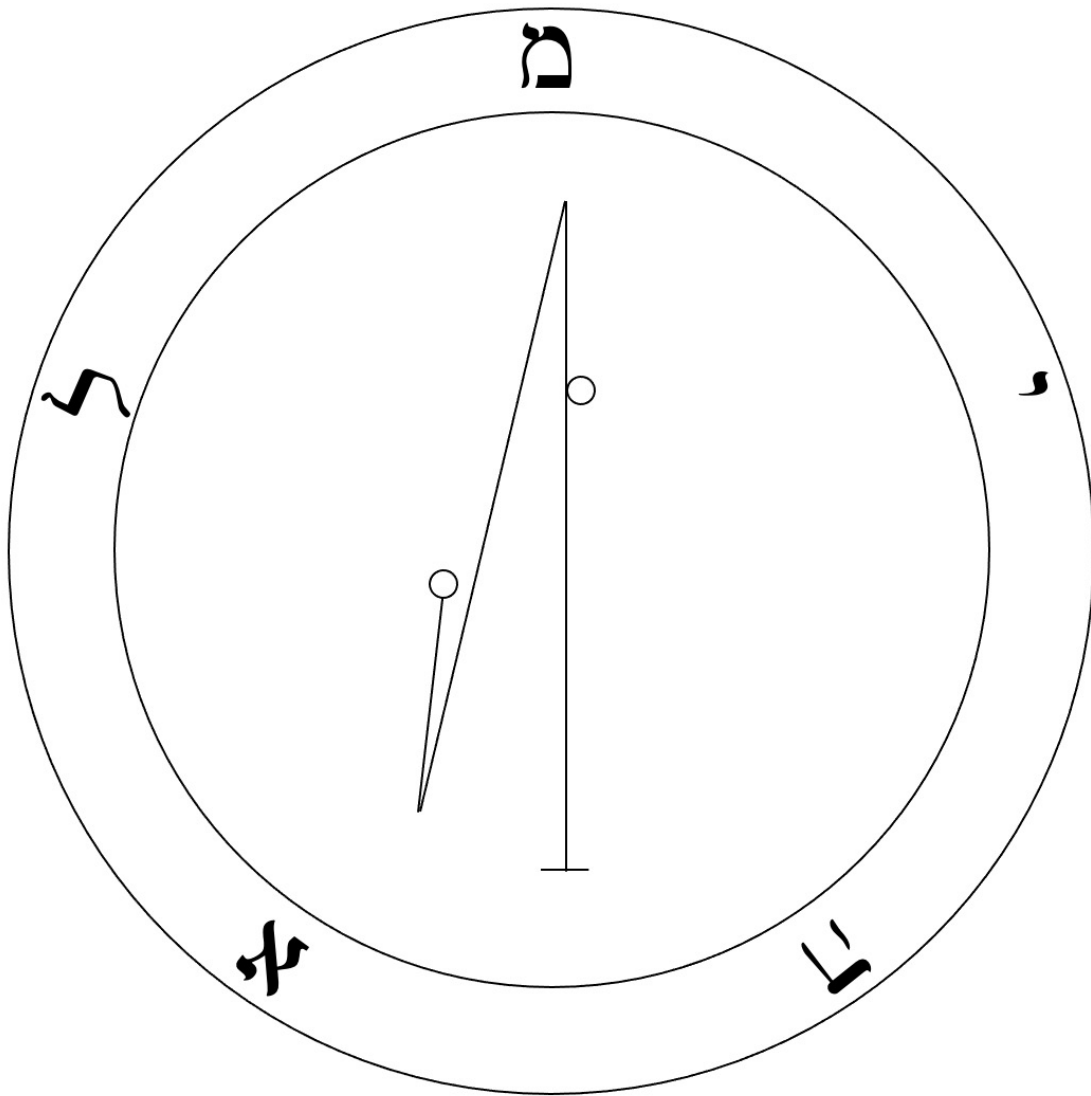

49

והואל

Vehuel

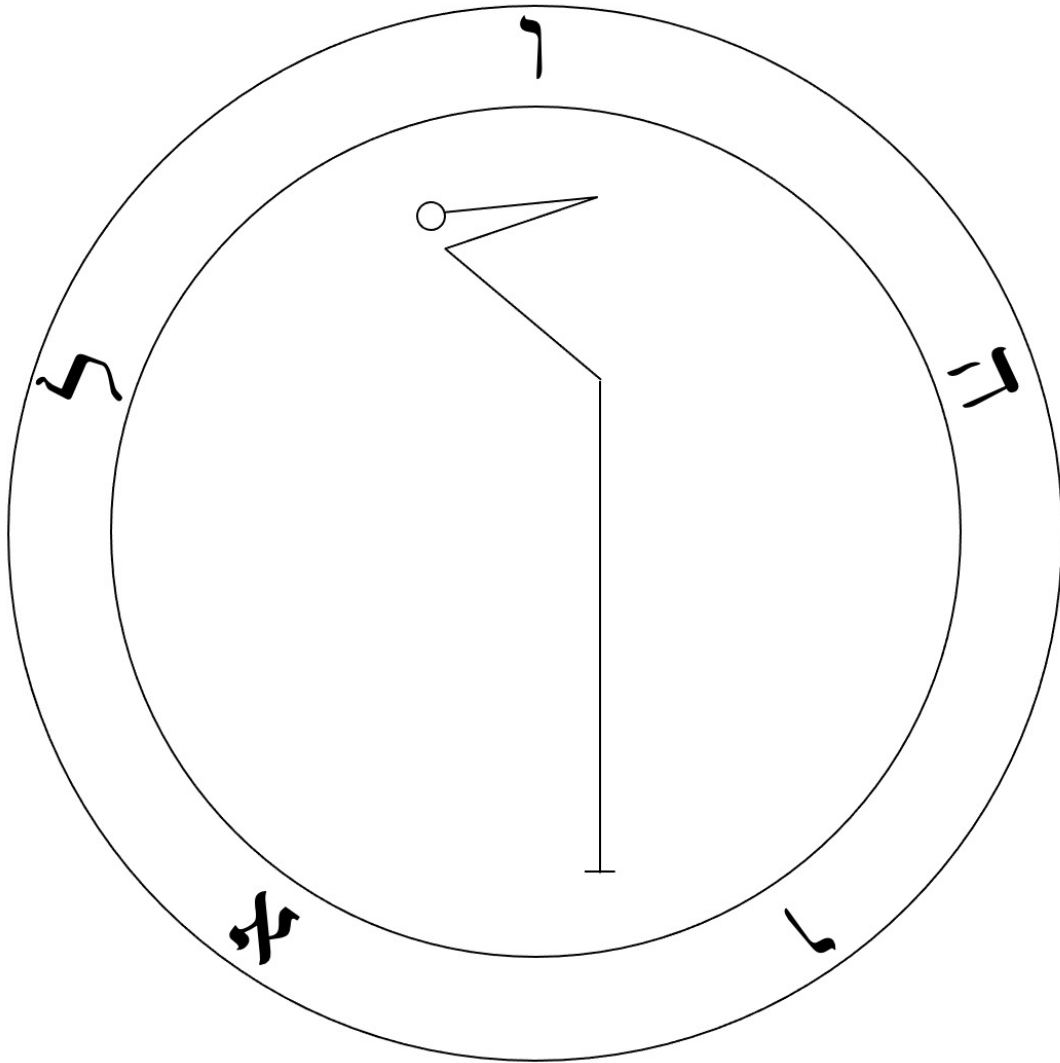

50

דניאל

Daniel

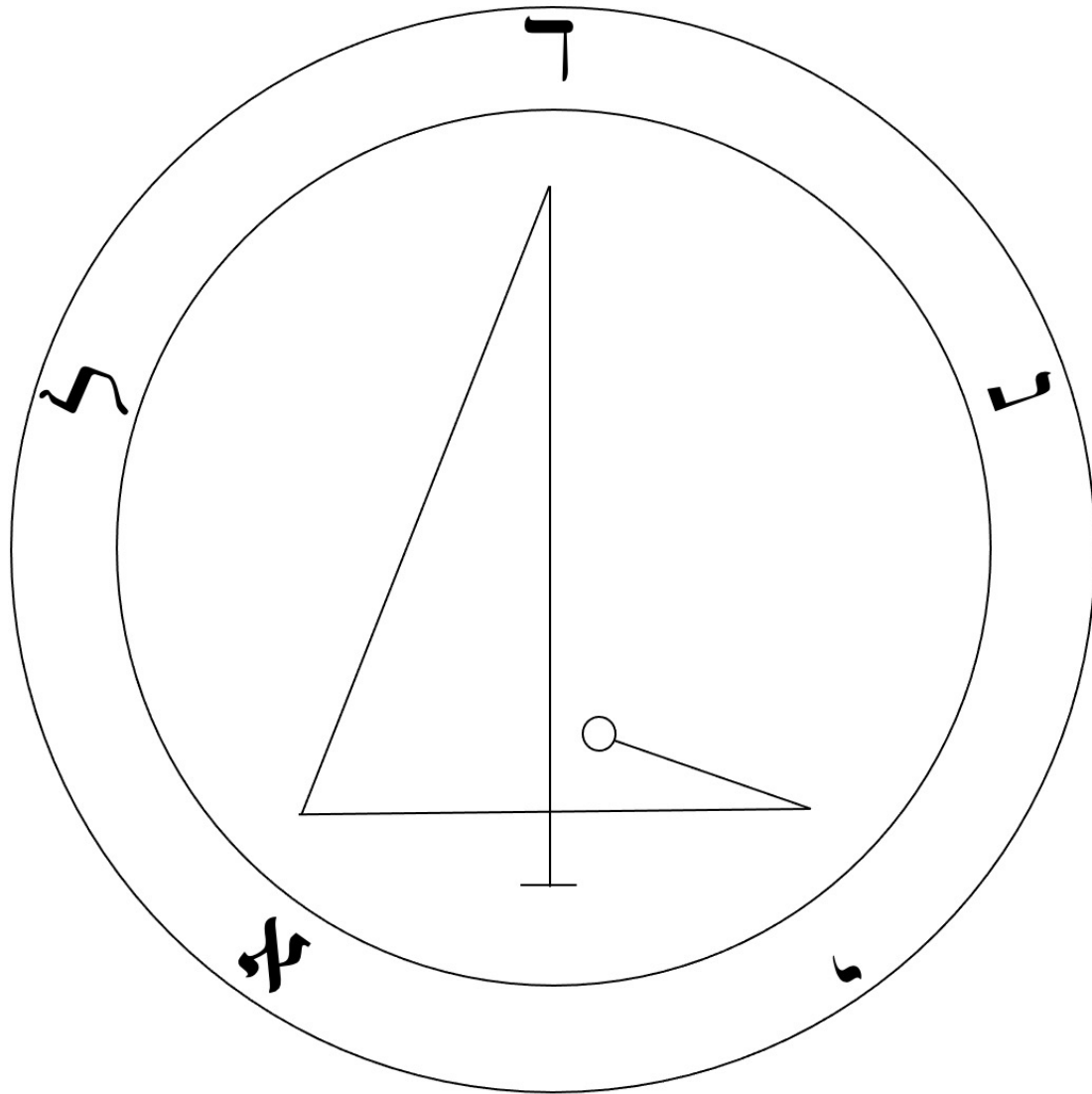

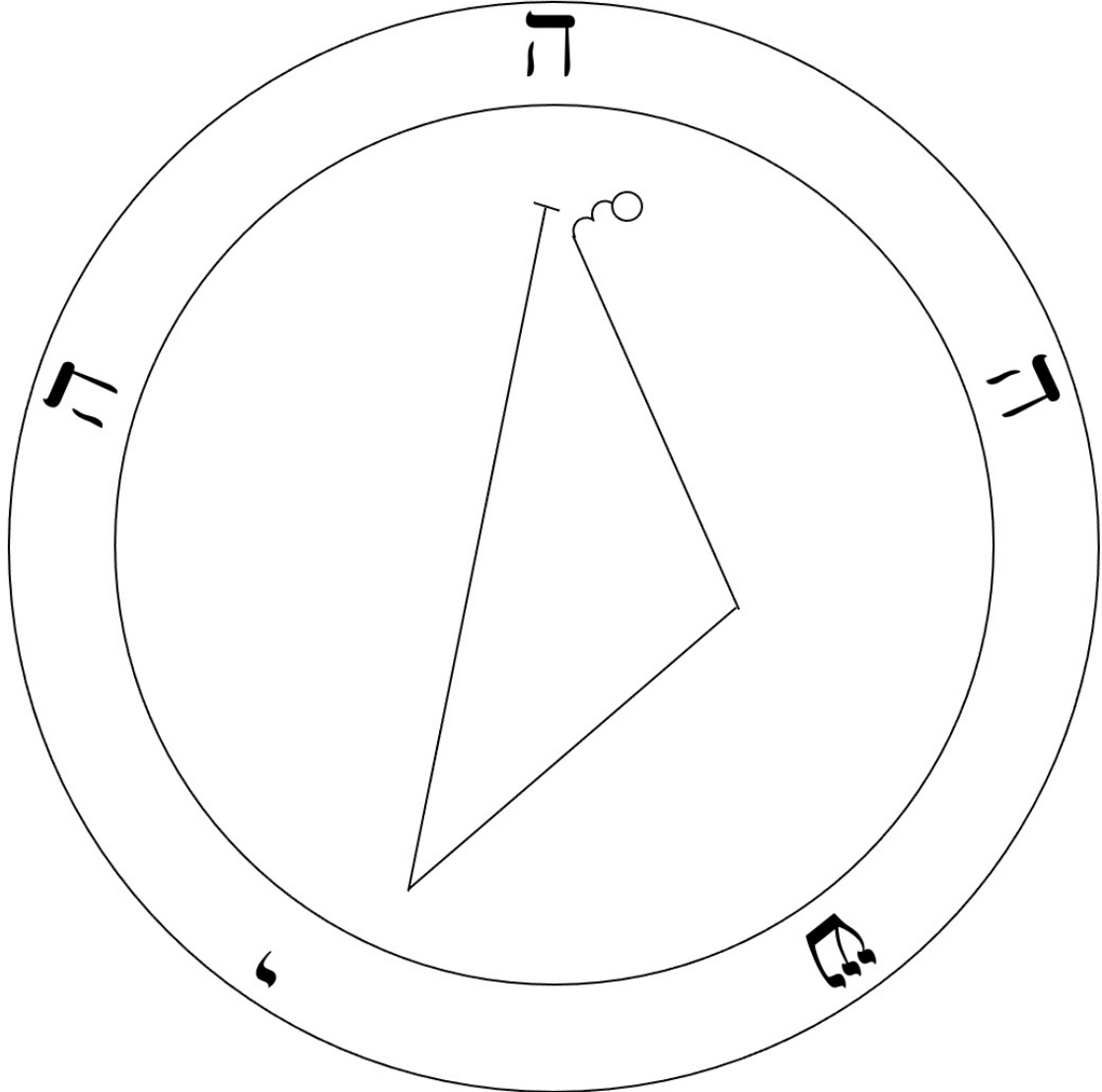
51	ההשיה	Hahasiah
 <p>The diagram is a circular sigil enclosed in a square border. It features two concentric circles. In the center is a triangle with its top vertex pointing upwards. From the top vertex, a vertical line extends to the top inner circle, ending in a small circle with a wavy line above it. Four Hebrew characters are positioned on the outer circle: 'ה' at the top, 'ה' on the left, 'ה' on the right, and 'ה' at the bottom. The bottom 'ה' is stylized with three small circles below it.</p>		

52

עממיה

Imamah

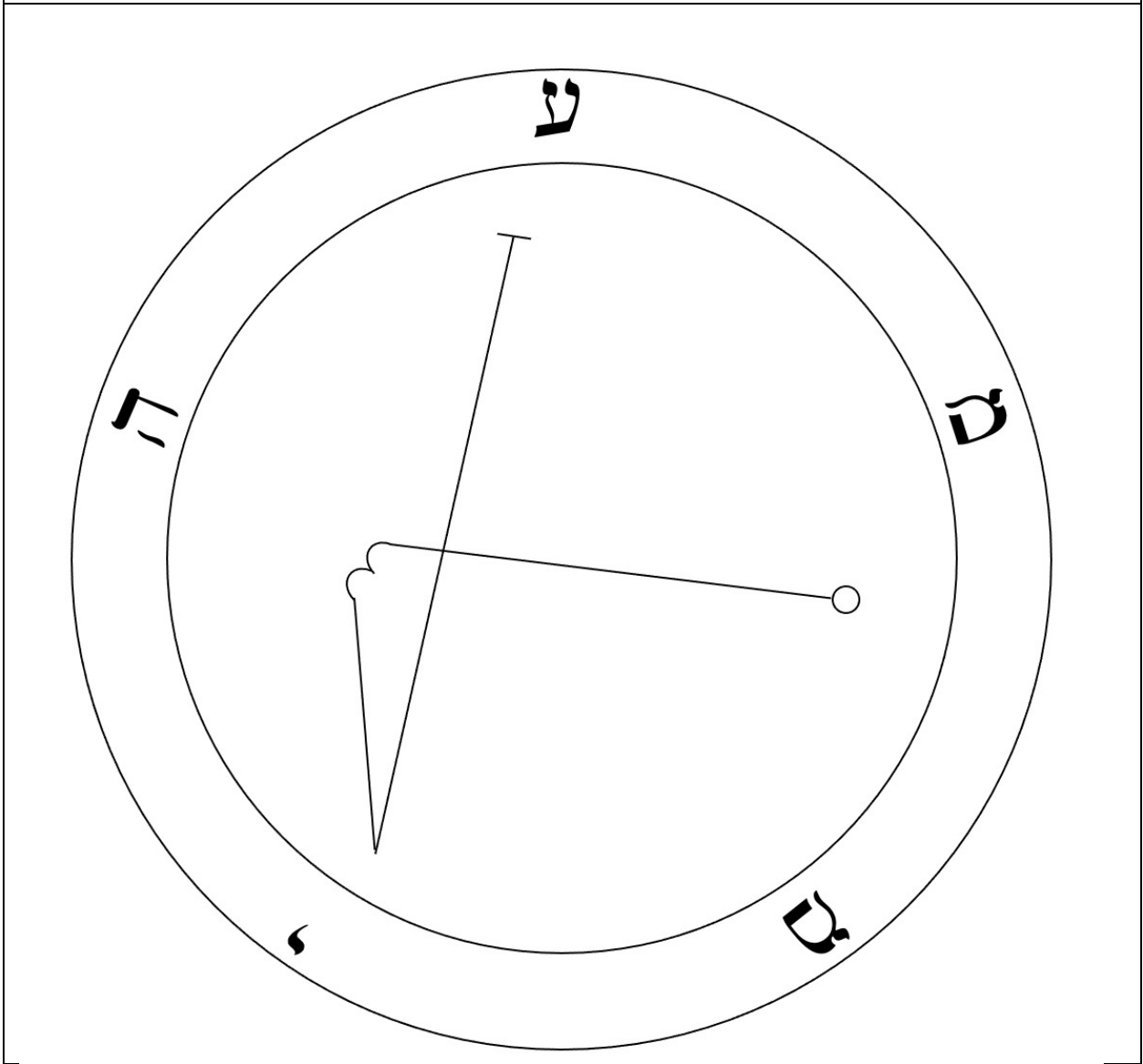

53

ננאל

Nanael

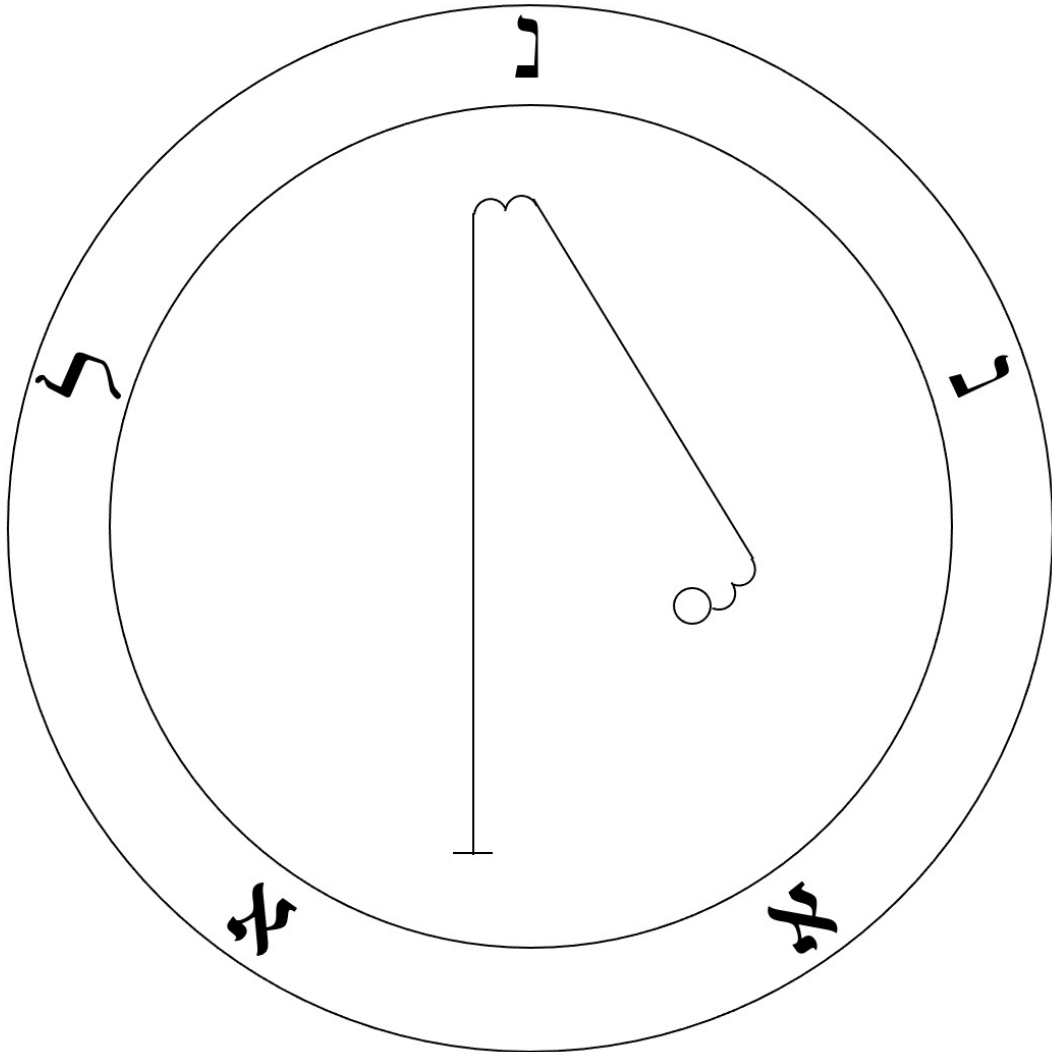

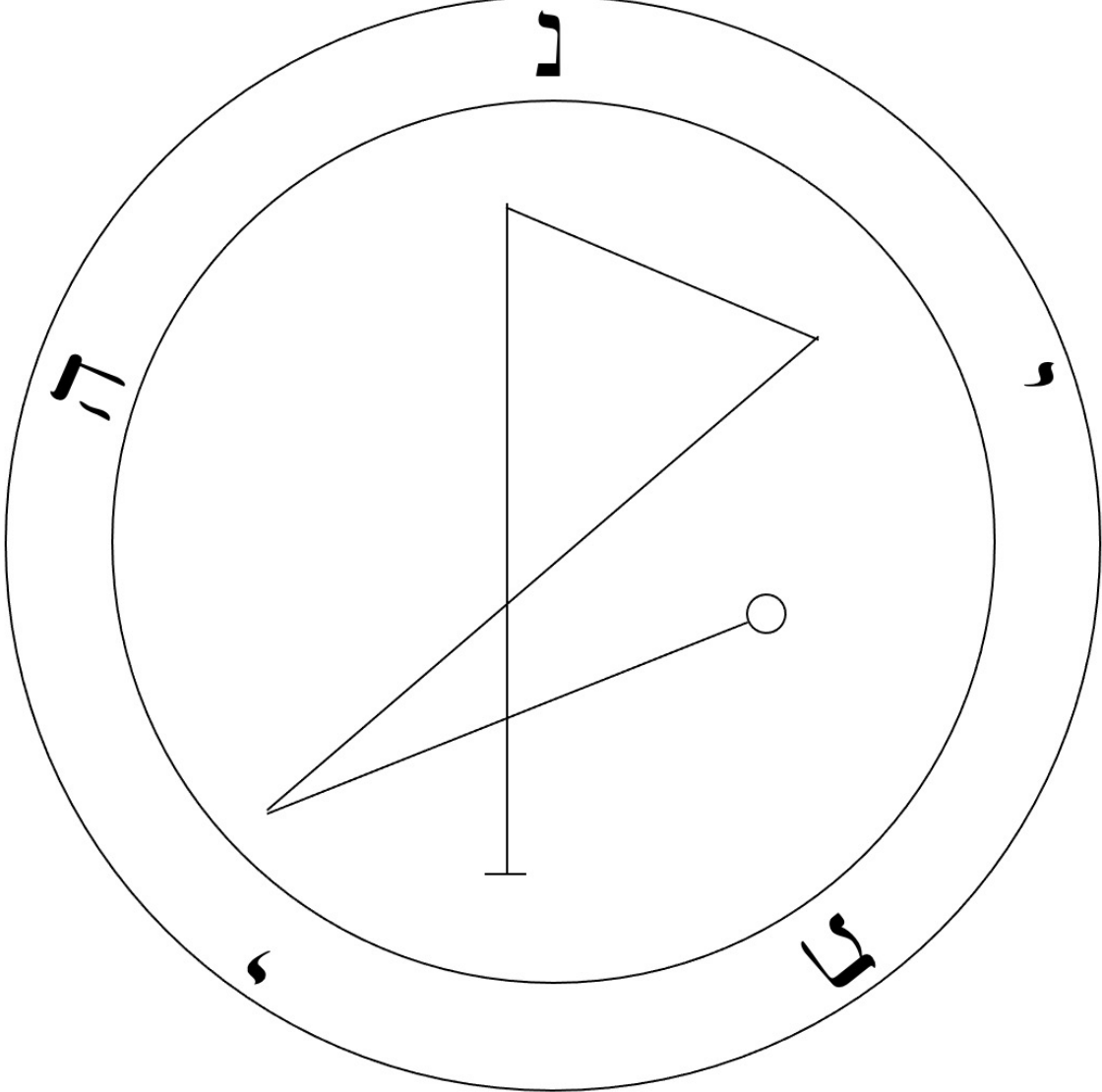
54	ניתאל	Nithanael
 <p>The sigil for Nithanael is enclosed in a square frame. It features two concentric circles. The outer circle contains four Hebrew characters: נ (Nun) at the top, ח (Chet) on the left, א (Aleph) at the bottom, and ט (Tet) on the right. Inside the circles, there is a triangle with a vertical line extending from its top vertex to a horizontal base. A diagonal line runs from the bottom-left vertex to the top-right vertex. A second diagonal line runs from the bottom-left vertex to a small circle located in the lower-right quadrant of the inner circle.</p>		

55

מבהיה

Mebahiah

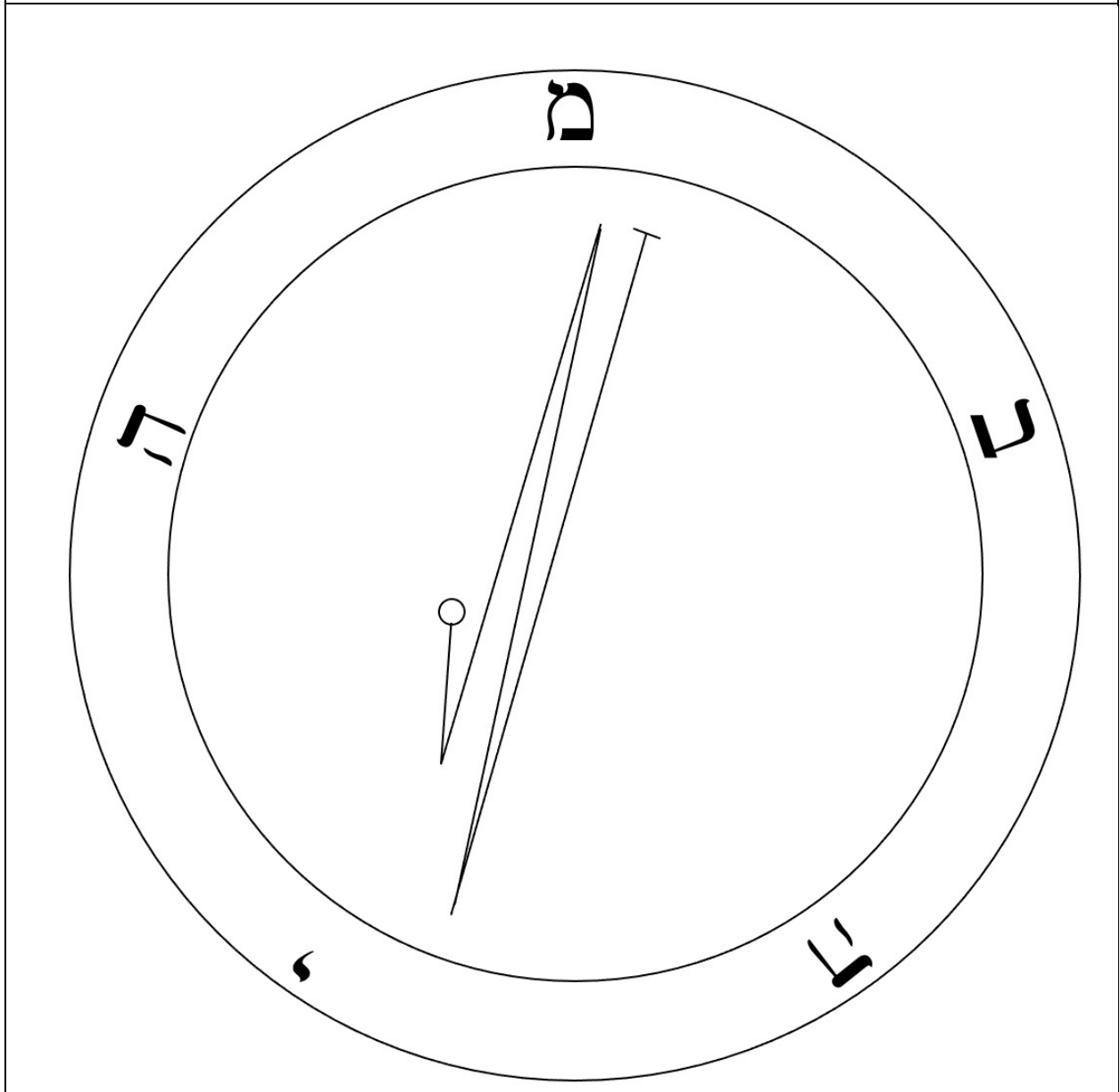



56

פויאל

Poiel

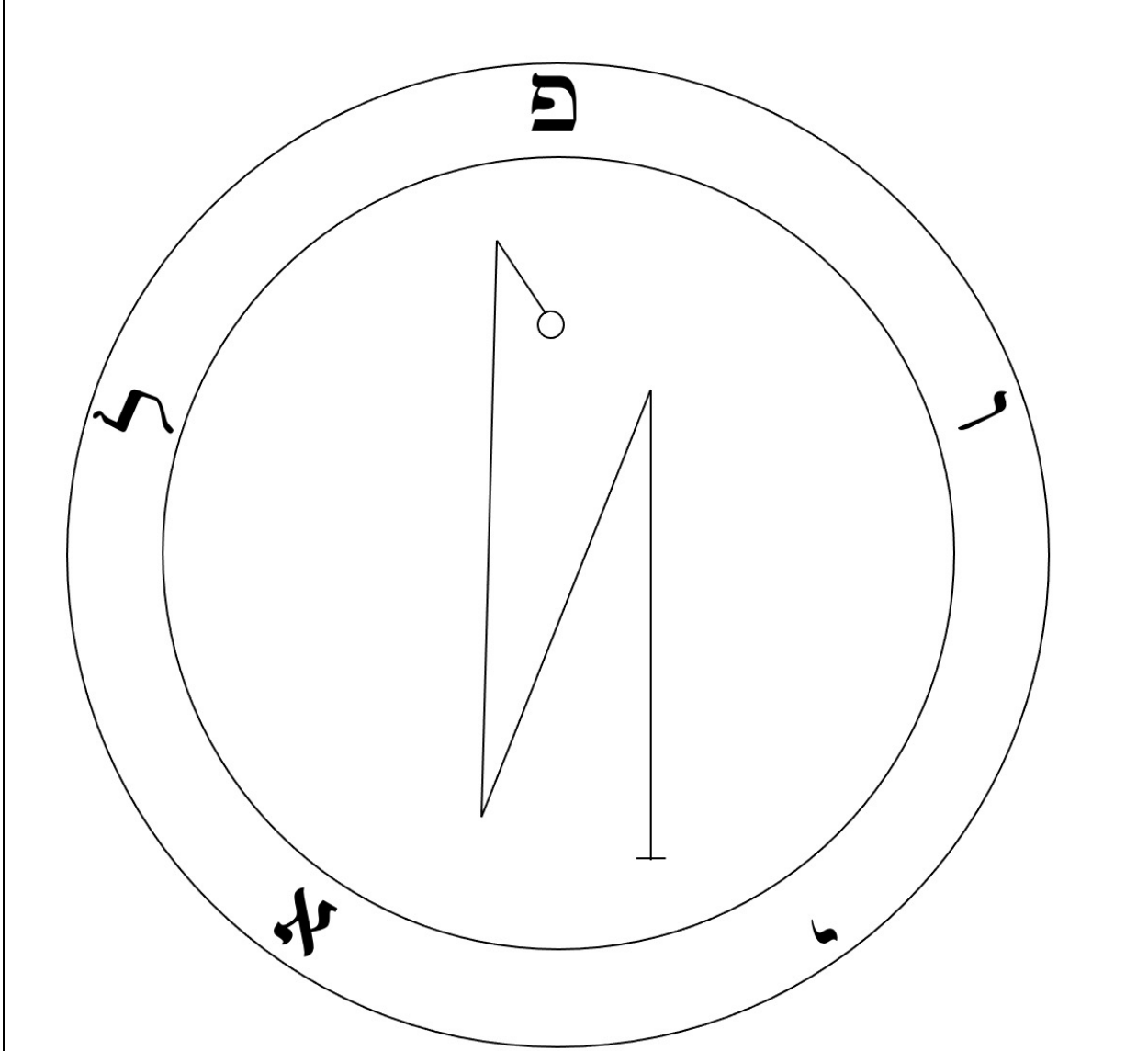

57

נממיה

Nemamiah

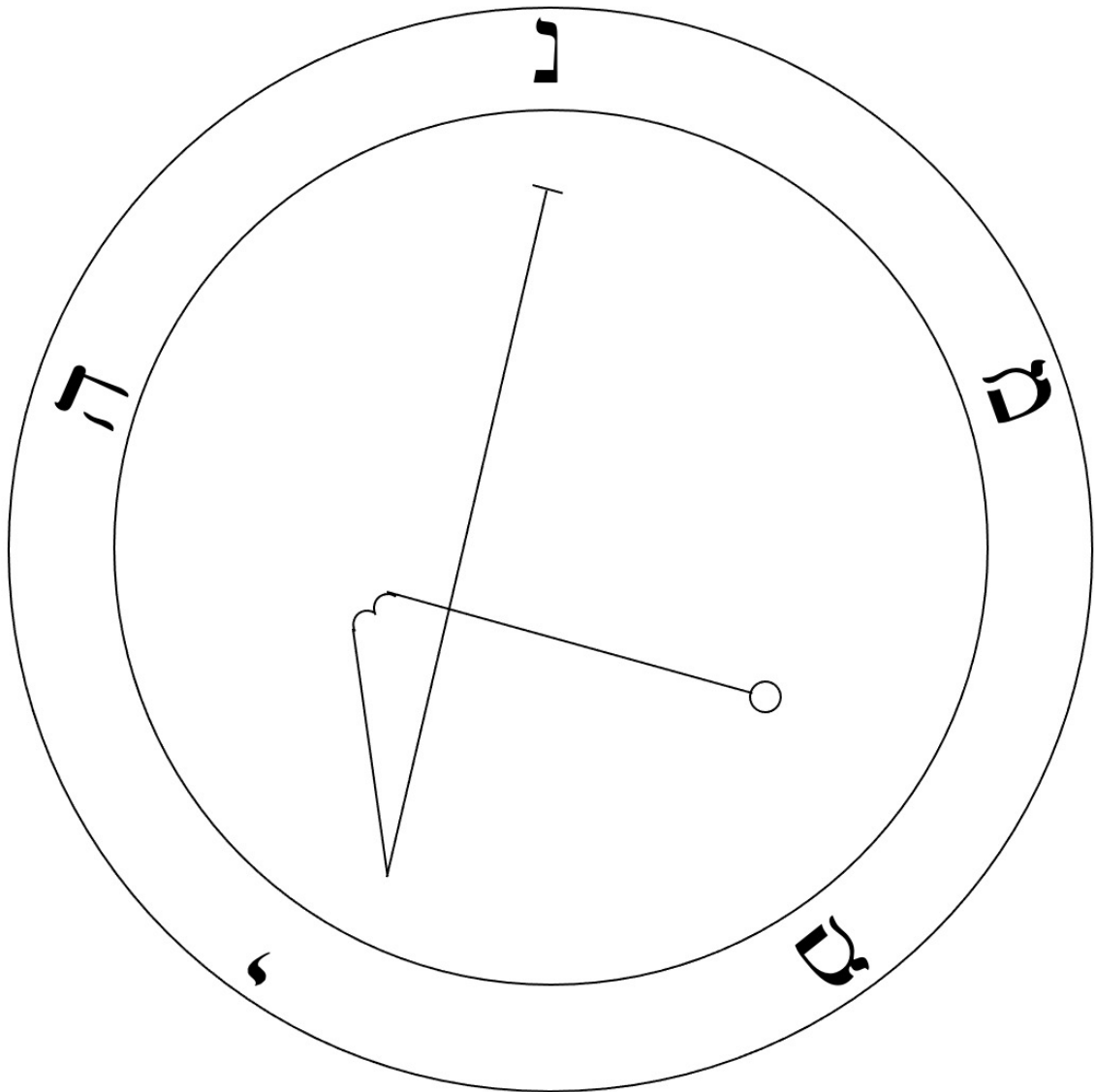

58

יִי־לֵאל

Ieialel

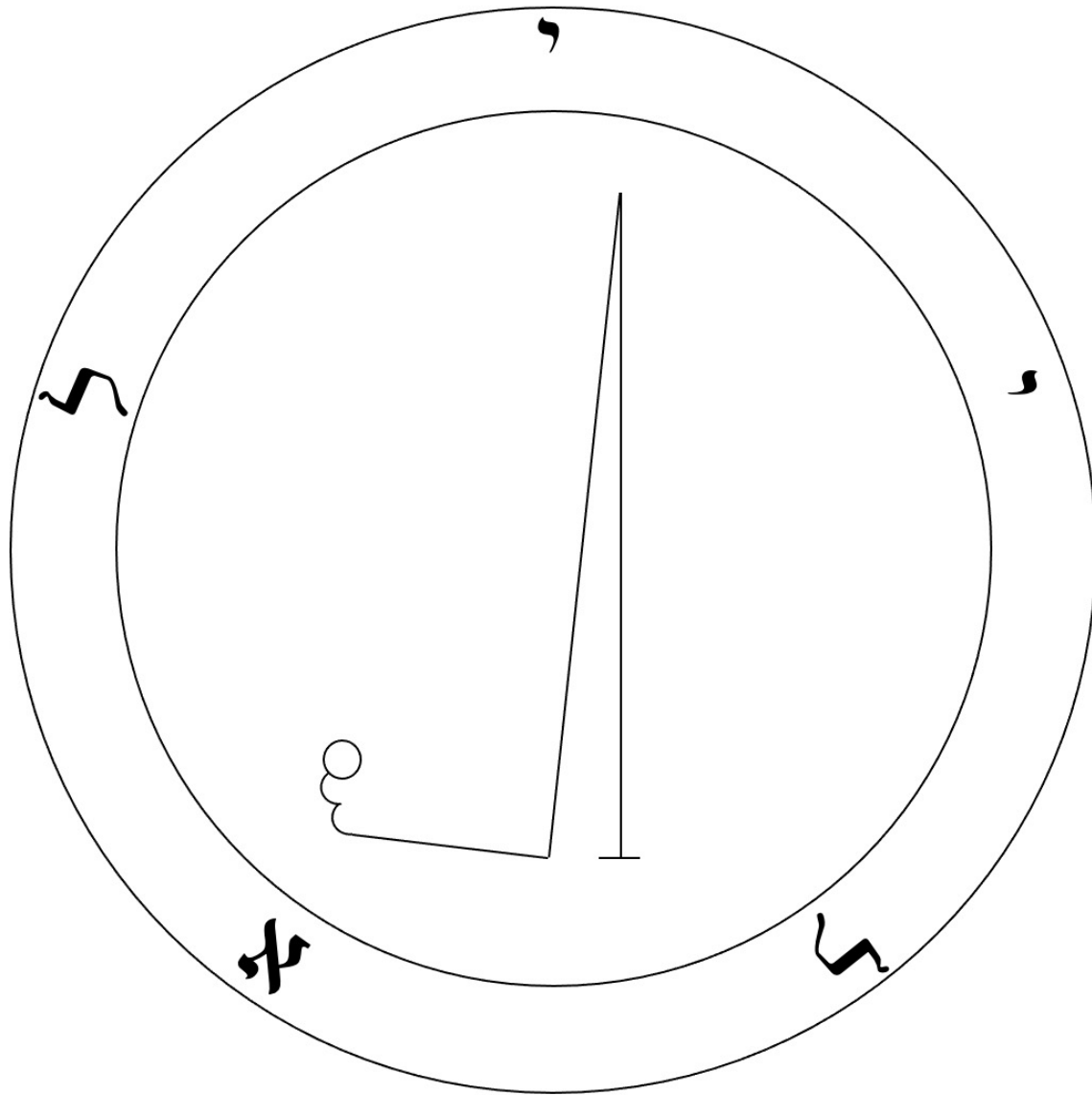

59

הרהאל

Harahel

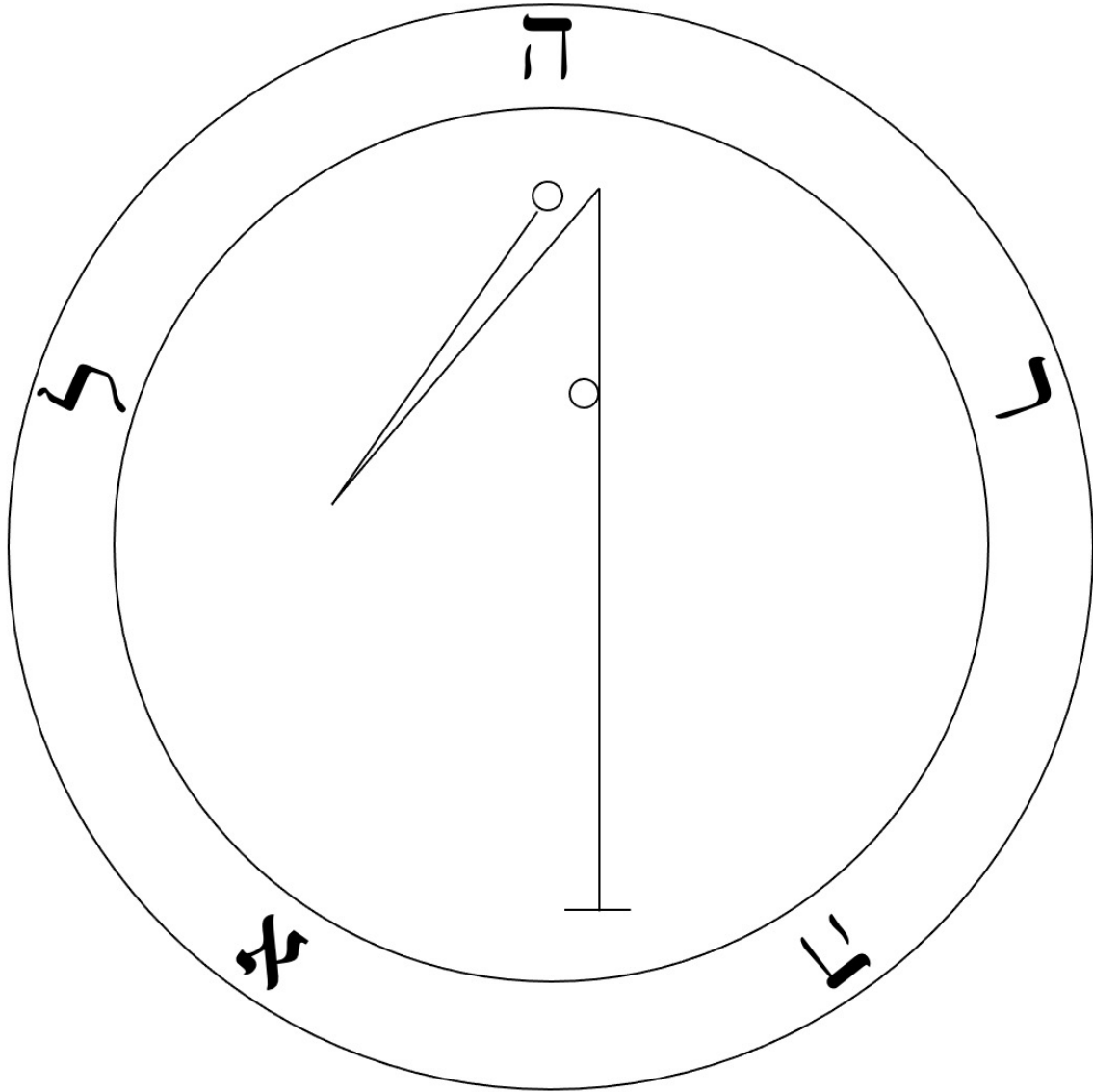

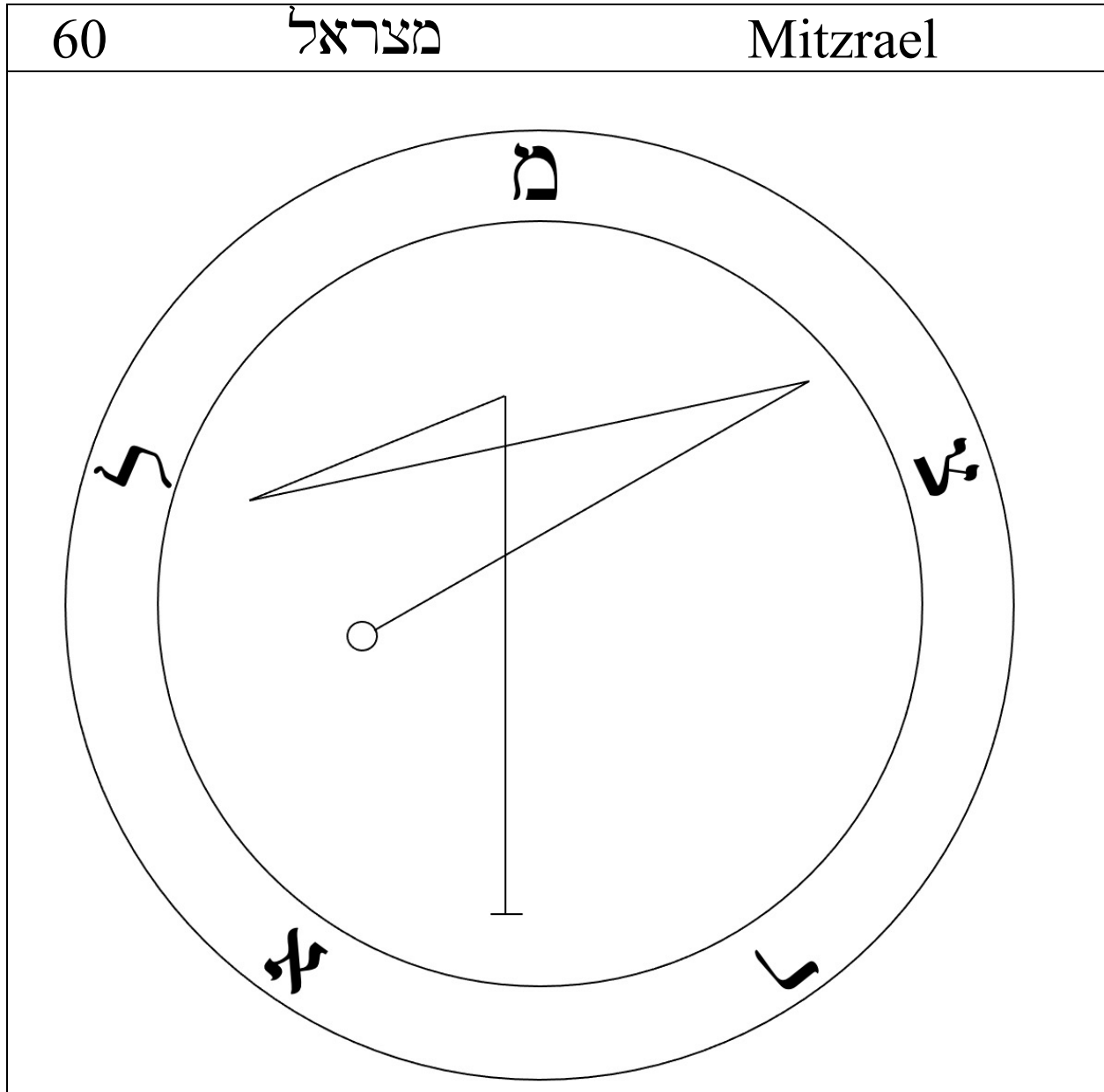

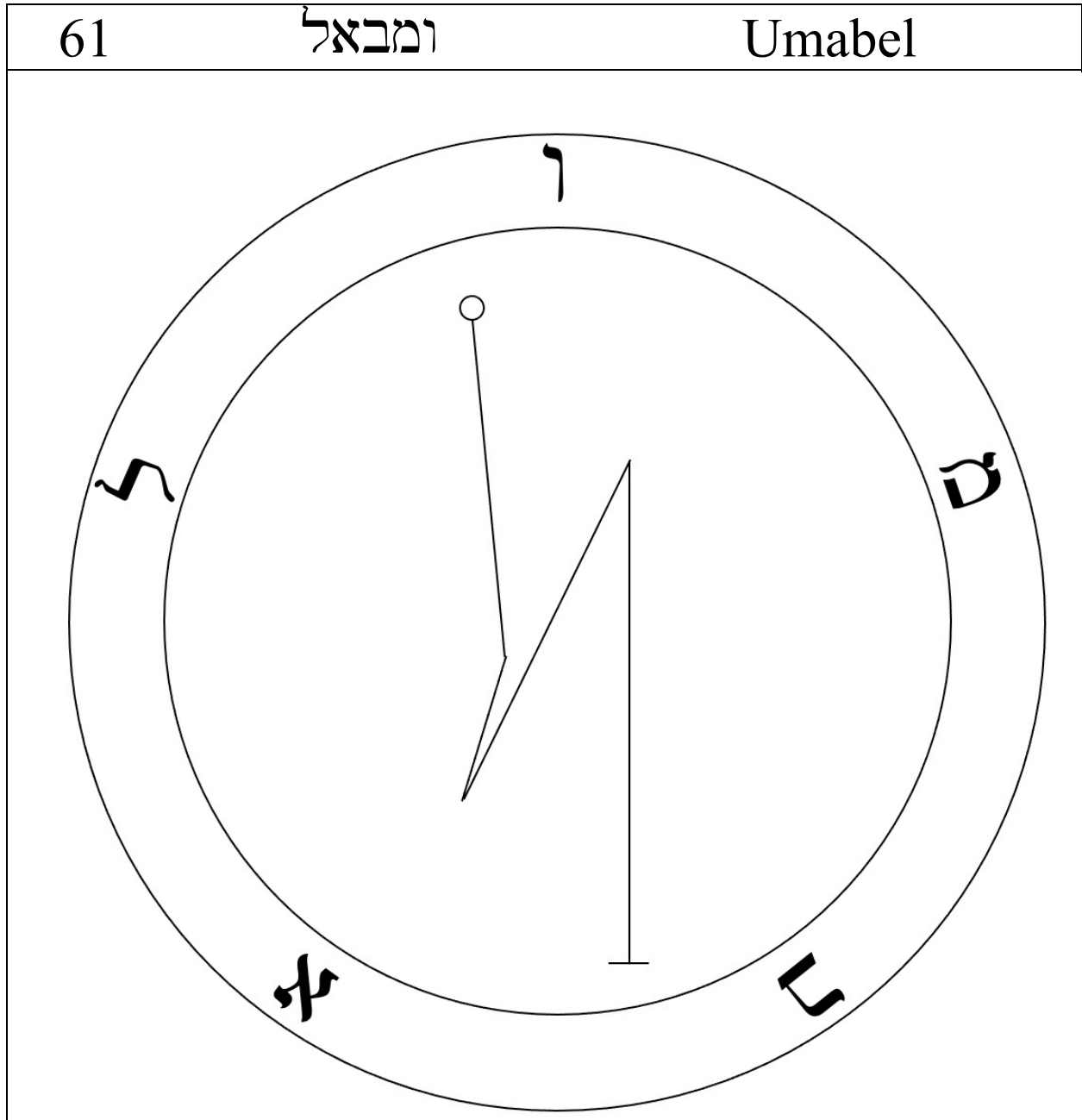

62

יההאל

Iah-hel

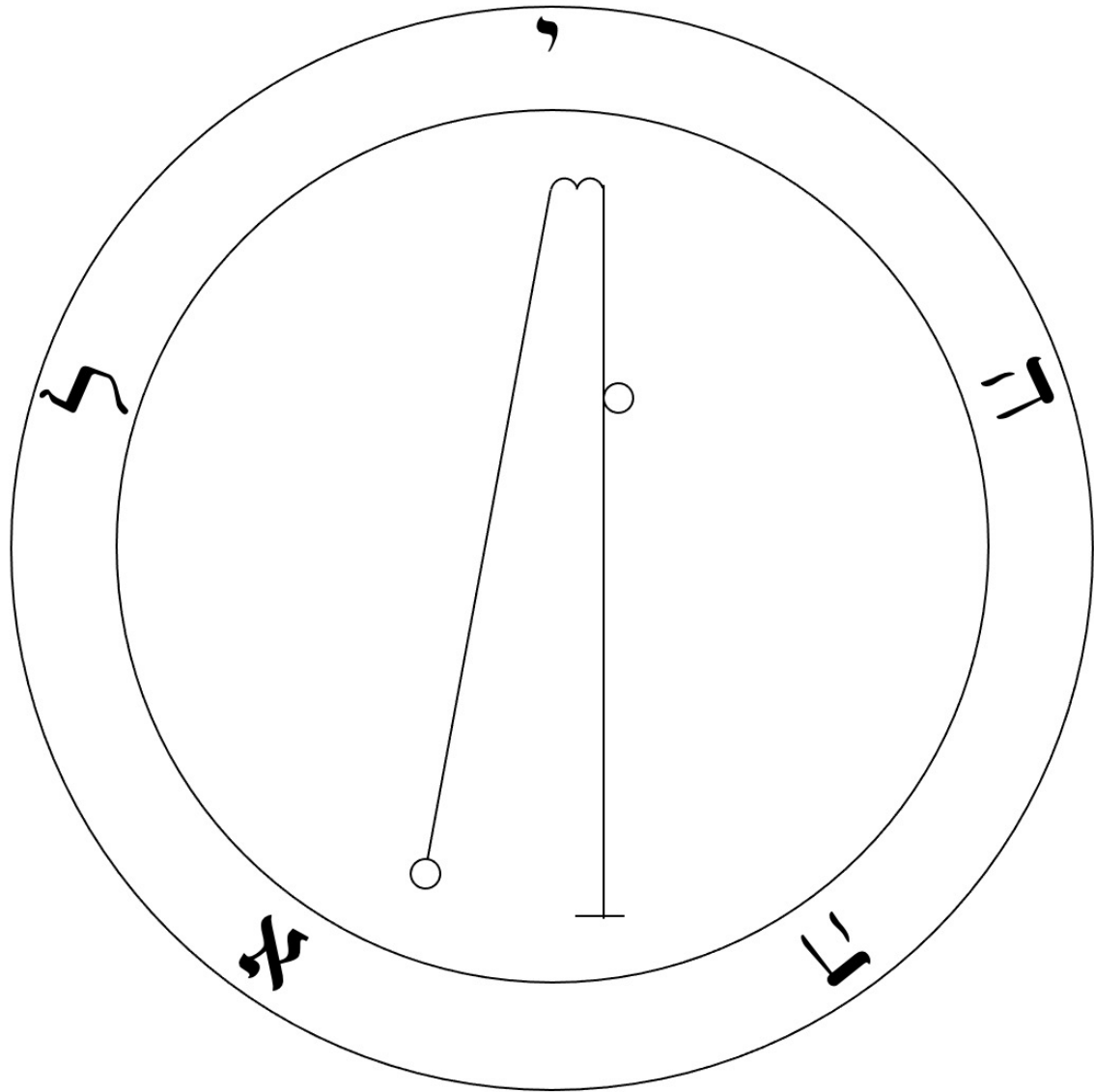

63

ענואל

Anael

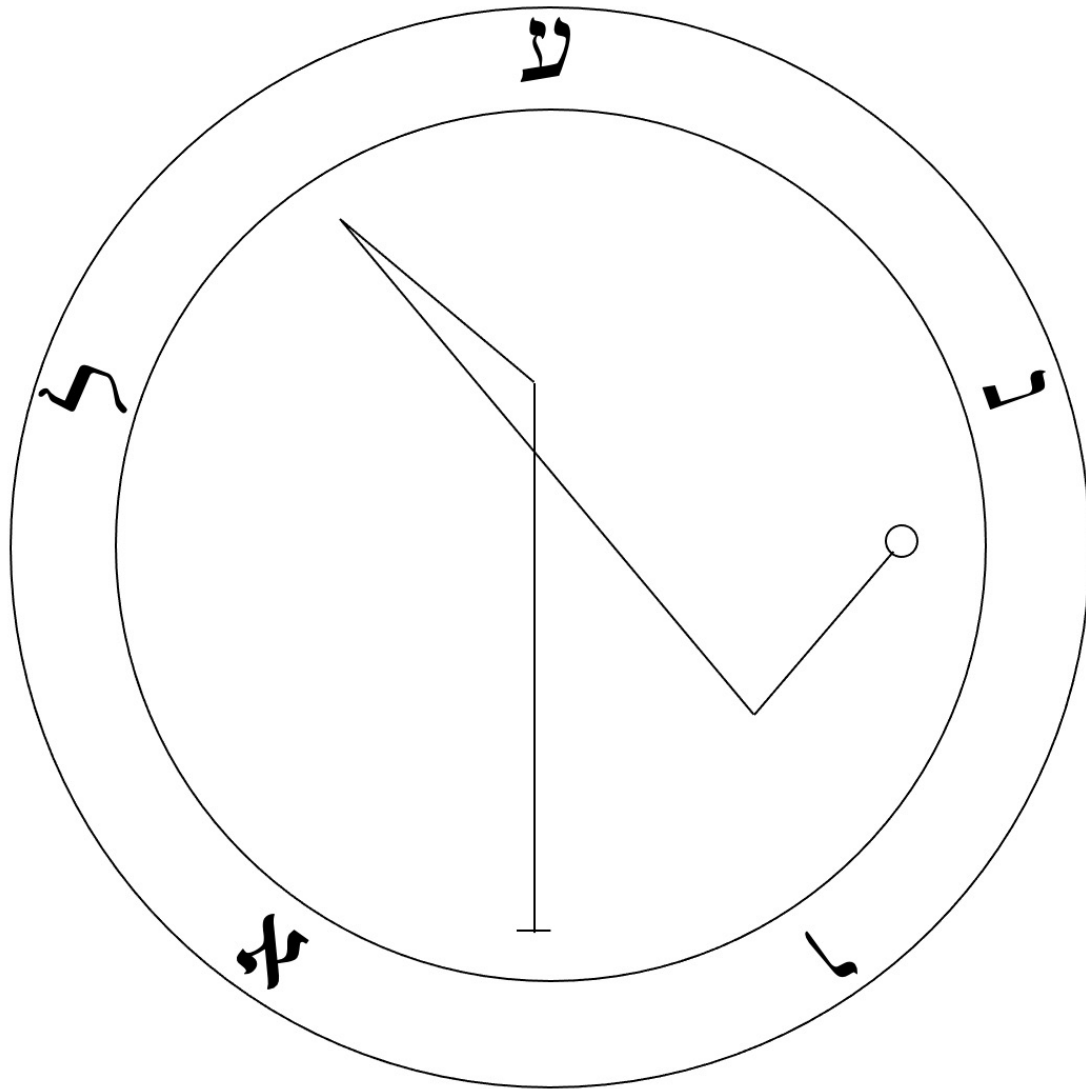



64

מהיאל

Mehiel

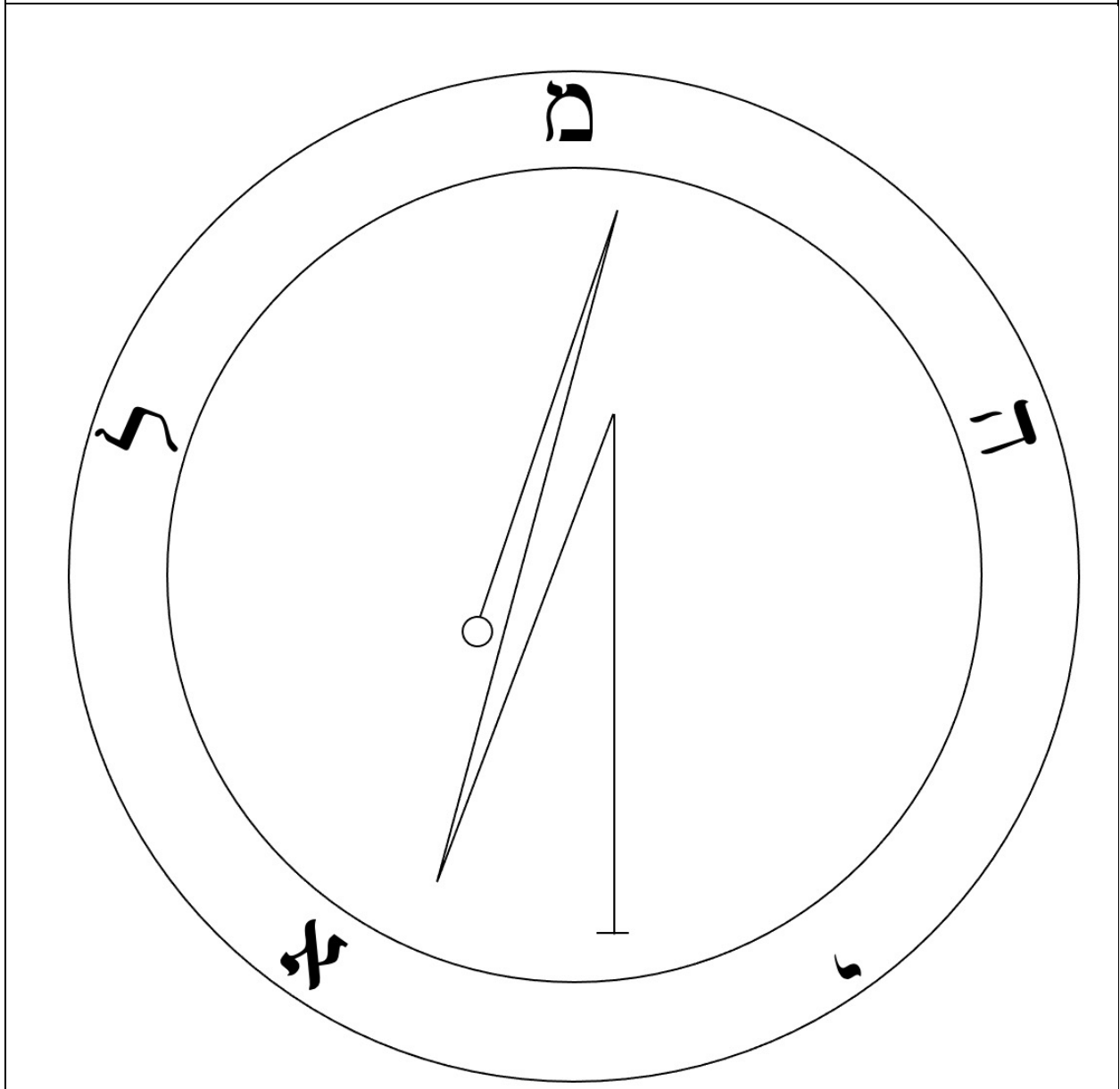

65

דמביה

Damabiah

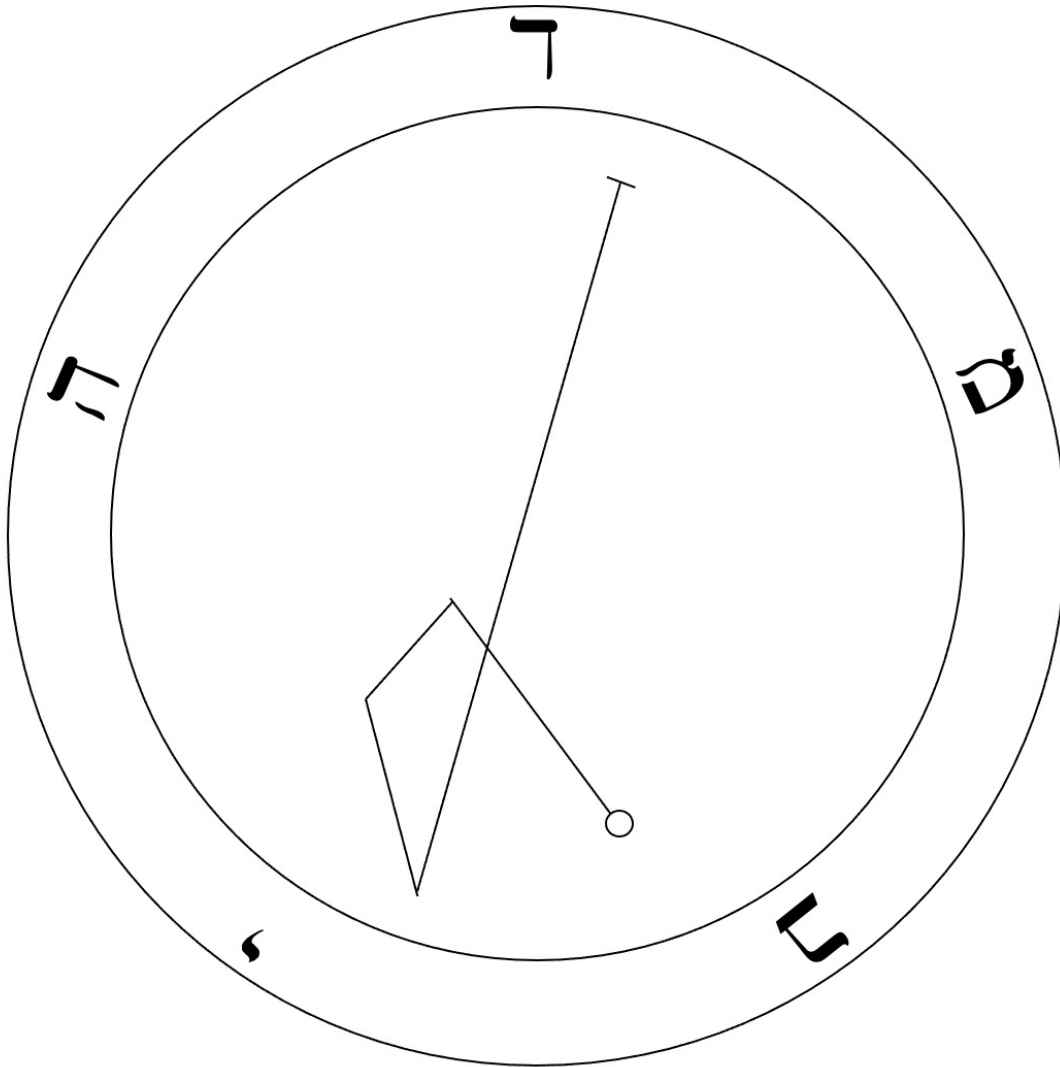

66

מנקיה

Manakel

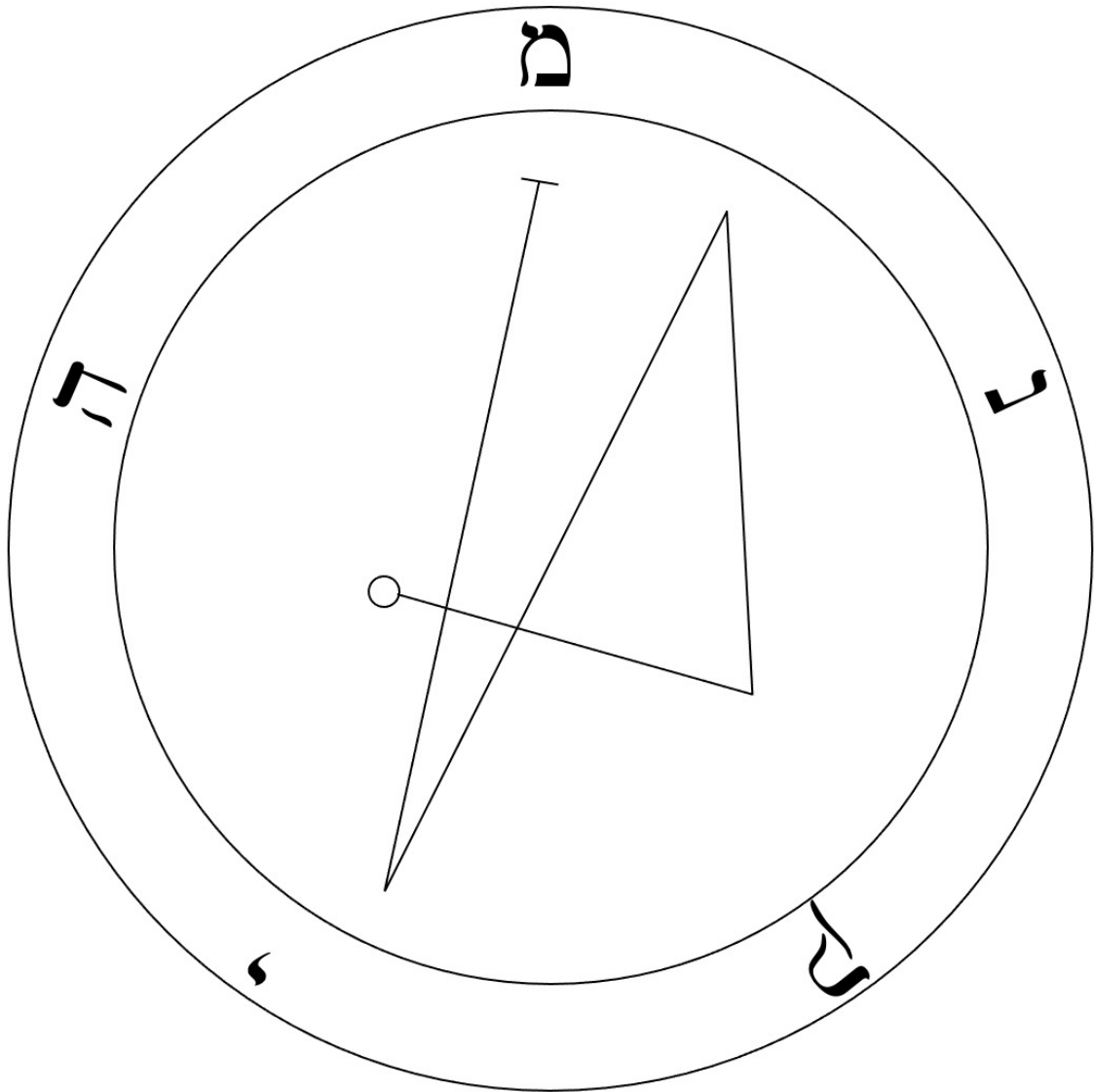

67

איעאל

Eiael

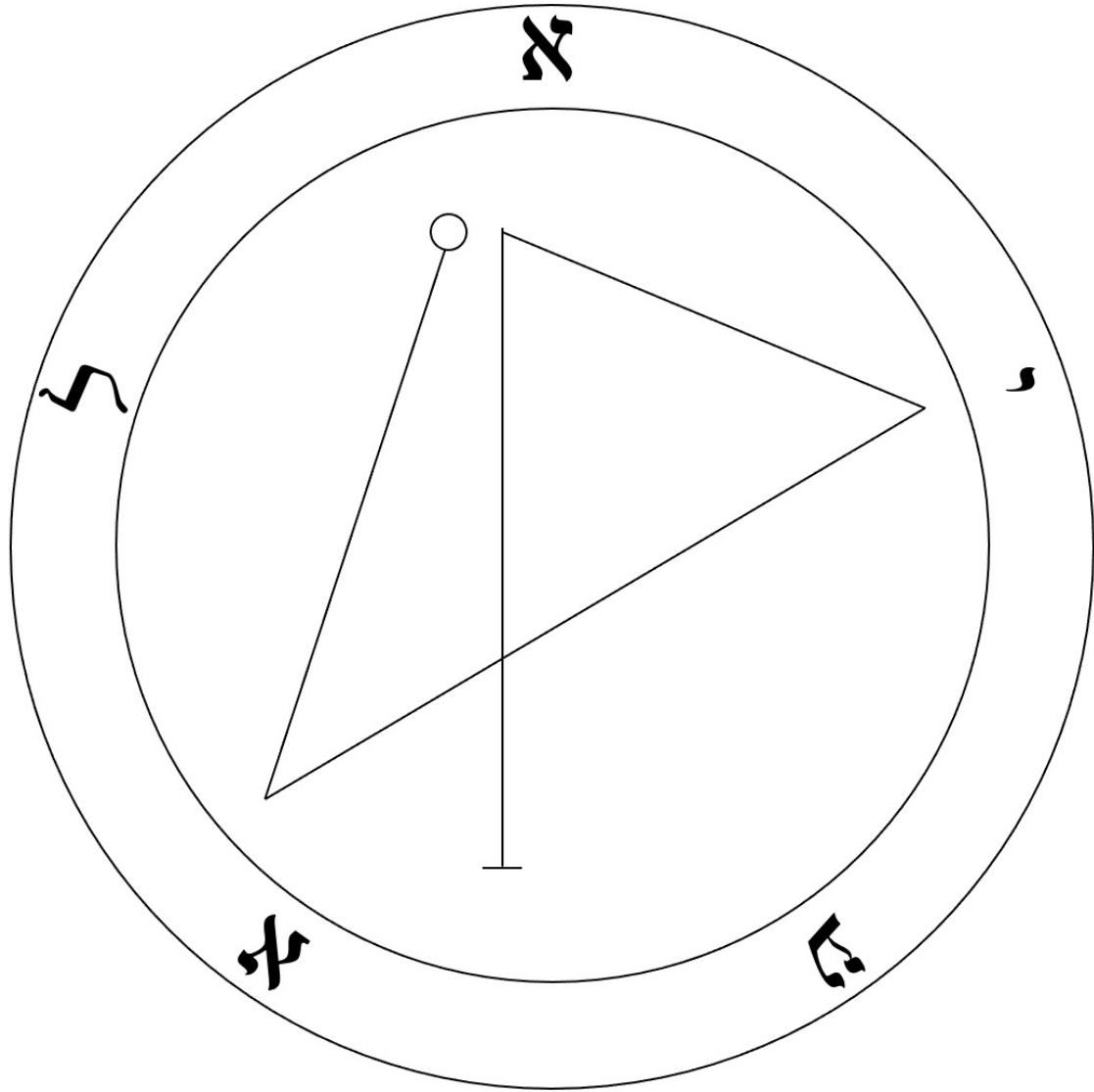

68

הבויה

Habuhiah

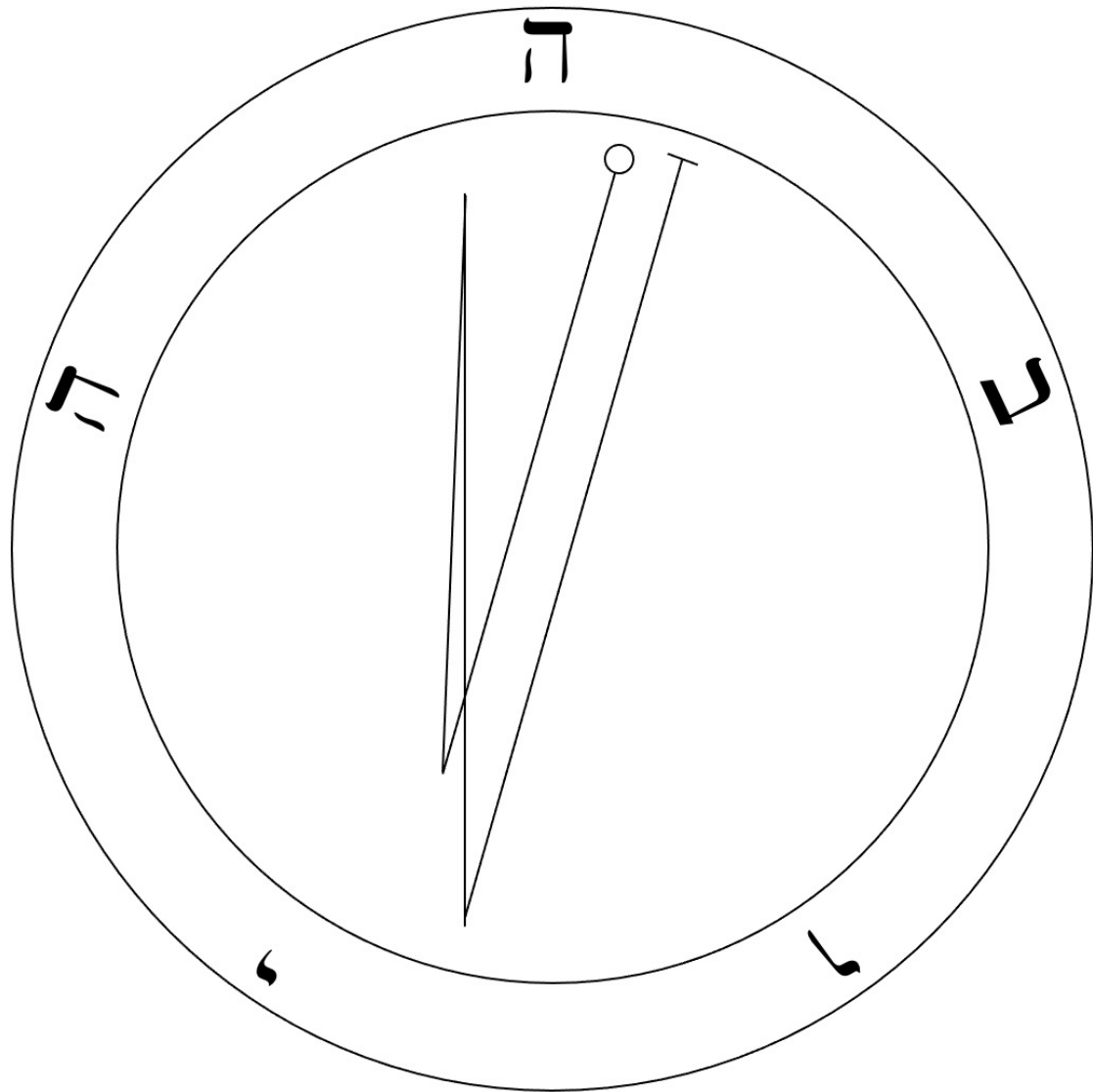

69

ראהל

Rochel

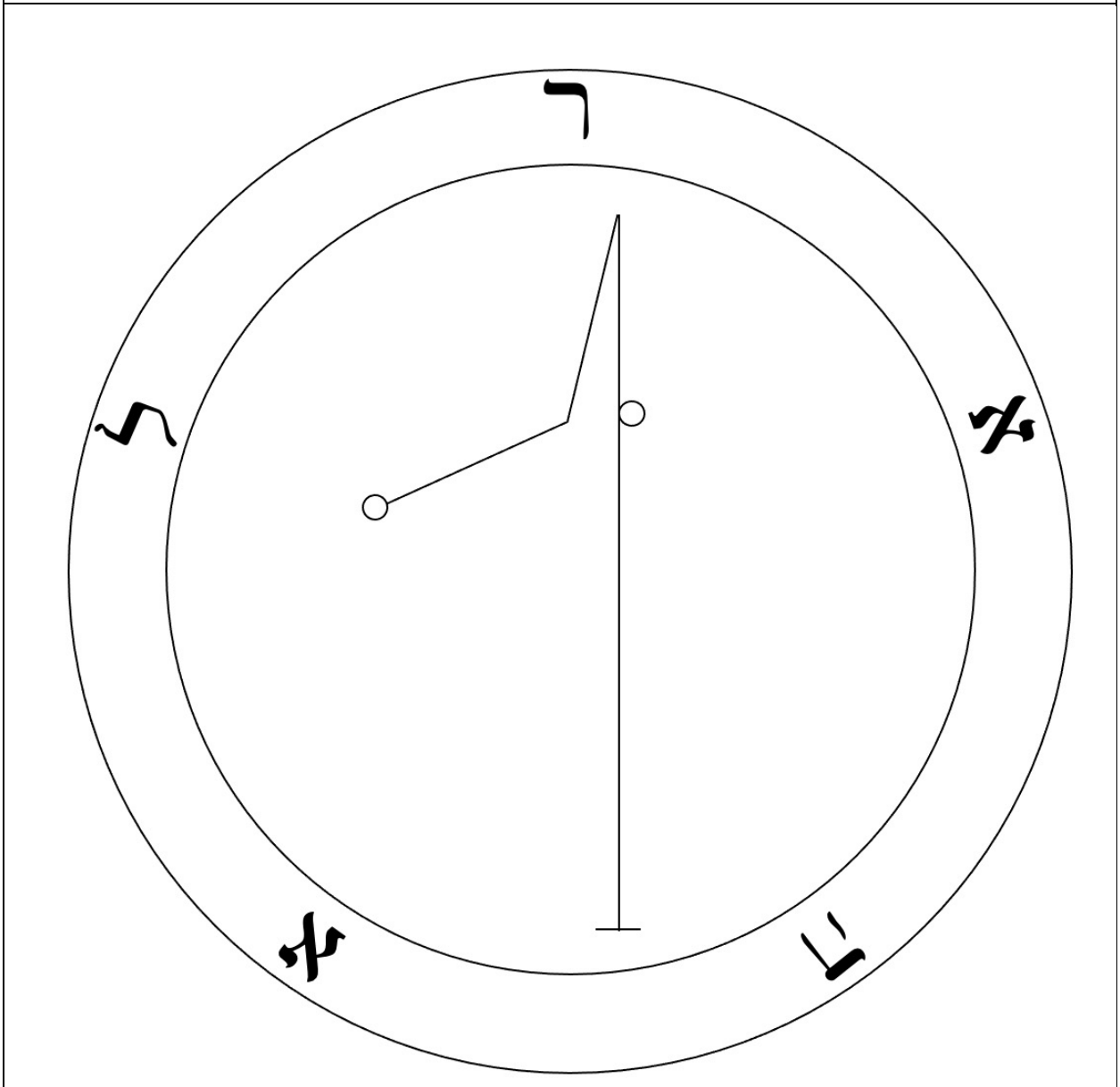

70

יבמיה

Jabamiah

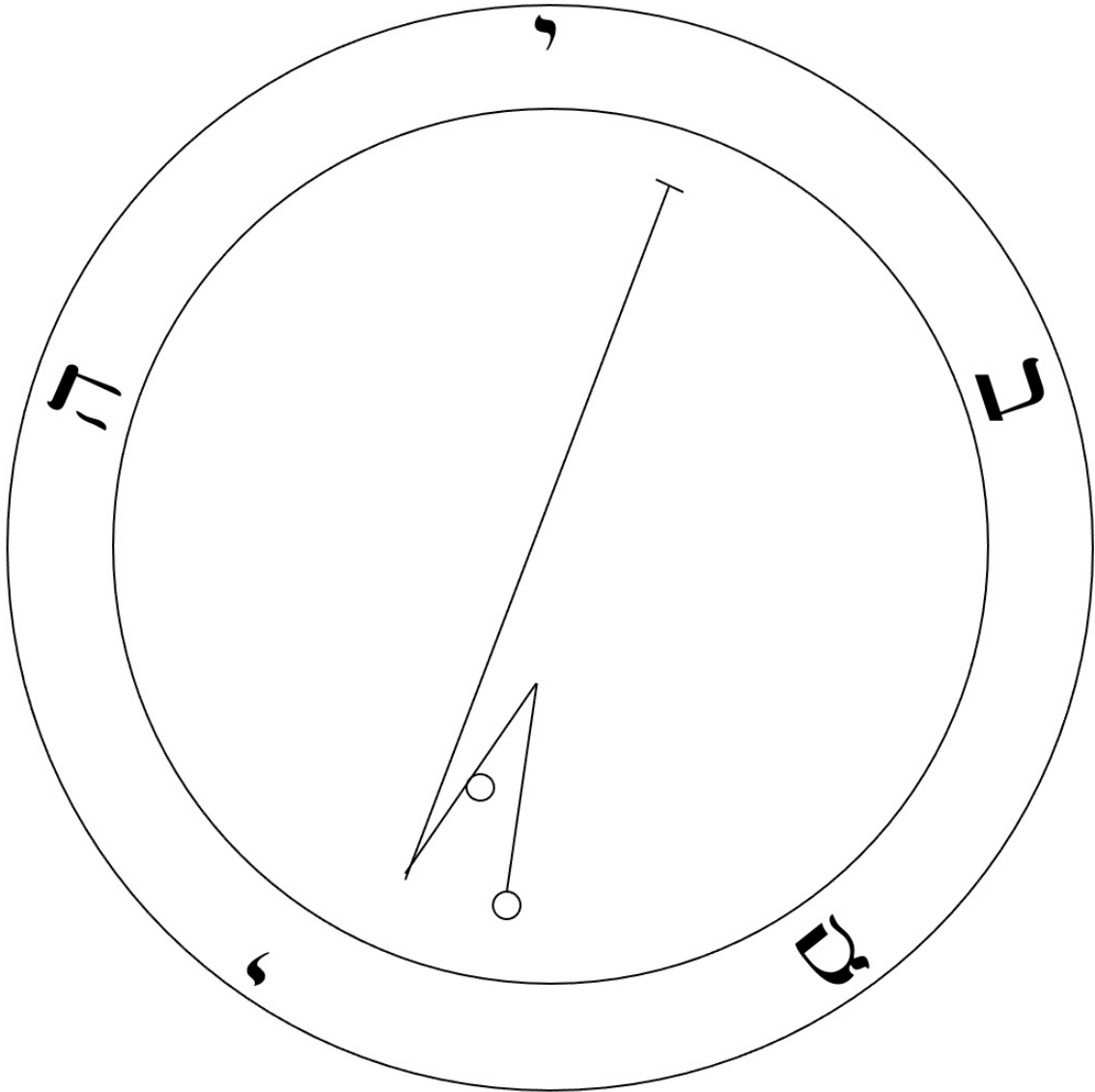

71

היאל

Haiaiel

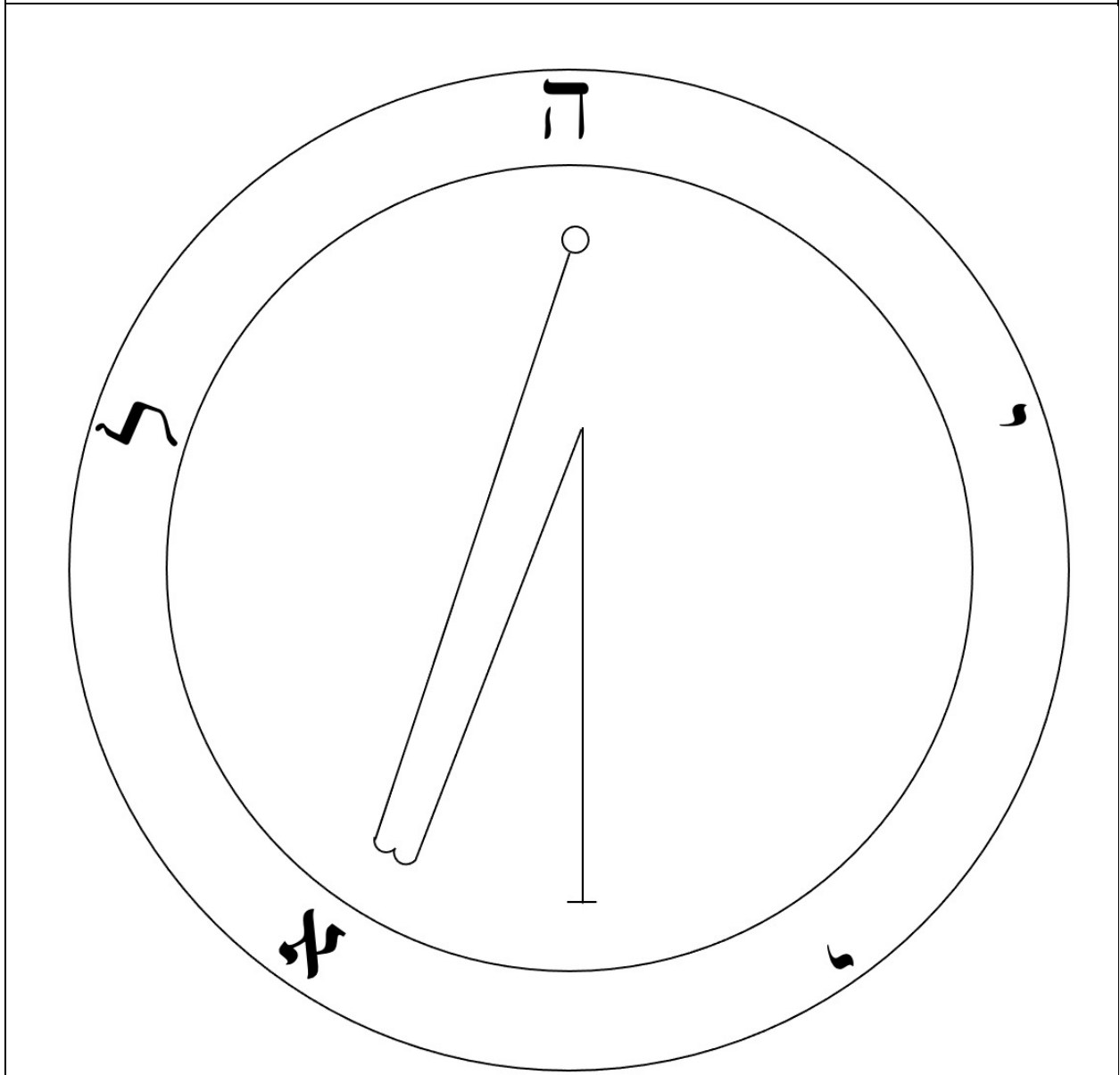



72

מומיה

Mumiah

